

# Battery Box

## High Voltage LFP

### Stackable Battery Box

# User Manual

---

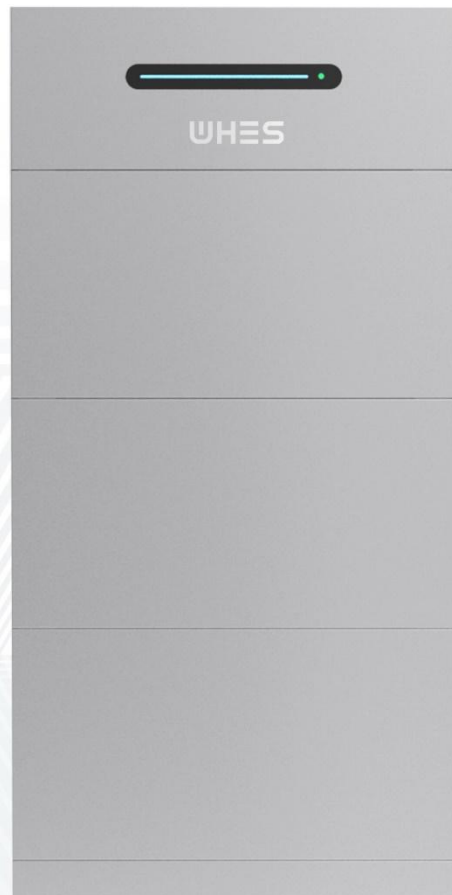

WH-BXC4992-1S  
WH-BXC4992-2S  
WH-BXC4992-3S  
WH-BXC4992-4S  
WH-BXC4992-5S  
WH-BXC4992-6S

---

# CONTENTS

<b>COPYRIGHT STATEMENT .....</b>	<b>1</b>
<b>1 NOTE ON THIS MANUAL .....</b>	<b>1</b>
1.1 Applicable Model .....	1
1.2 Target Group .....	1
1.3 Symbols in the Manual .....	1
1.4 Symbols on the Product .....	2
1.5 Version .....	3
<b>2 SAFETY .....</b>	<b>4</b>
2.1 General Safety .....	4
2.2 Before Connecting .....	4
2.3 In Using .....	5
<b>3 INTRODUCTION.....</b>	<b>6</b>
3.1 Product Overview .....	6
3.2 Features.....	6
3.3 Application Scenarios.....	7
3.4 Dimensions.....	7
3.5 Indicator Status and Communication Port .....	8
3.6 Product identity definition .....	13
3.7 Technical Data.....	14
<b>4 INSTALLATION.....</b>	<b>15</b>
4.1 Packing List .....	15
4.2 Installation Location and Environment.....	17
4.2.1 General.....	17
4.2.2 Location Restrictions .....	18
4.2.3 Barriers to Habitable Rooms .....	18
4.2.4 Choosing an Installation Location.....	20
4.3 Installation Steps.....	21
<b>5 System Operation.....</b>	<b>29</b>
5.1 Check Before Turning ON .....	29
5.2 Turn ON the Battery System.....	29
5.3 Parallized battery systems.....	30
5.4 Turn off the Battery System.....	30
<b>6 Emergency Situations .....</b>	<b>31</b>
6.1 Battery Leakage.....	31
6.2 On Fire .....	31
6.3 Wet Batteries.....	31
6.4 Damaged Batteries.....	31
<b>7 Remarks .....</b>	<b>32</b>

---

7.1	Recycle and Disposal .....	32
7.2	Maintenance.....	32
7.3	Declaration of conformity .....	32

## **COPYRIGHT STATEMENT**

The copyright of this manual belongs to Jiangsu Weiheng Intelligent Technology Co., Ltd. Hereinafter referred to as WHES. Any corporation or individual should not plagiarize, partially or fully copy (including software, etc.), and no reproduction or distribution of it in any form or by any means. All rights reserved. Please properly store the manual and strictly follow all safety and operating instructions provided. Please do not operate the system before reading through this manual.

## **NOTICE**

The information in this user manual is subject to change due to product updates or other reasons. This guide cannot replace the product labels or the safety precautions in the user manual unless otherwise specified. All descriptions here are for guidance only.

# 1 NOTE ON THIS MANUAL

## 1.1 Applicable Model

This manual applies to the listed system models below:

### Myrtillo Series:

- WH-BXC4992-1S
- WH-BXC4992-2S
- WH-BXC4992-3S
- WH-BXC4992-4S
- WH-BXC4992-5S
- WH-BXC4992-6S

It describes the information, installation, electrical connection, commissioning, and maintenance and troubleshooting of the product. Please read it carefully before operating.

## 1.2 Target Group

This manual applies to qualified electricians. The qualified electricians have to be familiar with the product, local standards, and electric systems. The tasks described in this manual should only be performed by qualified electricians.

## 1.3 Symbols in the Manual

Important instructions contained in this manual should be followed during installation, operation and maintenance.

### DANGER

Indicates a hazard with a high level of risk that, if not avoided, will result in death or serious injury.

### WARNING

Indicates a hazard with a medium level of risk that, if not avoided, could result in death or serious injury.

### CAUTION

Indicates a hazard with a low level of risk that, if not avoided, could result in minor or moderate injury.

### NOTICE

Indicates a situation that, if not avoided, could result in equipment or property damage.

## 1.4 Symbols on the Product

The follow types of warning and safety symbols appearing on the product are described below:



Caution!

Failing to observe warnings indicated in this manual may result in injury.



**Danger to life due to electric shock**

The product operates at high voltages. All work on the product must be carried out by qualified persons only.



**Risk of burns due to hot surfaces**

The product can get hot during operation. Avoid contact during operation. Allow the product to cool down sufficiently before carrying out any work.



Heavy objects. Life with care.



Keep the battery from open fire or ignition sources.



Recyclable product components.



This side up. The package must always be transported, handled, and stored upright, with the arrows pointing upwards.



Do not stack more than five identical packages on top of each other.

WEEE designation



Do not dispose of the product together with the household waste but in accordance with the locally applicable disposal regulations for electronic waste.



Handle the package/product with care, and do not tip it over or throw it.



Observe the documentation

Observe all documentation supplied with the product.



Keep dry

The package/product must be protected from excessive humidity and stored covered.



CE marking

The product complies with the requirements of the applicable EU

---

directives.

---

## 1.5 Version

The latest document contains all the updates made in previous versions.

### **V1.0 2024-03-05**

- First Issue.

### **V1.1 2025-04-25**

- Company brand information change.

### **V1.2 2025-07-01**

- Added description about installation location near the sea in Section 4.2.4.

## 2 SAFETY

Please strictly follow these important instructions in the manual and the label on the products during the Installation, communication, operation and maintenance.

### 2.1 General Safety

Please strictly follow these safety instructions in the user manual during the operation.

- It is important and necessary to read the user manual carefully (and attachment) before installing or using battery. Failure to do so or to follow any instruction or warning in this document can result in electrical shock, serious injury, and death, or damage battery, potentially rendering it unusable.
- If long-term storage is required, the battery system should be recharged every 6 months, and no less than 85% of SOC should be charged.
- Do not connect power terminal reversely.
- All power supplies must be disconnected during maintenance.
- Please contact the supplier within 24 hours if there is something abnormal.
- Do not use any neutral detergent to clean the product.
- Do not expose battery to flammable or irritating chemicals or vapor.
- Do not paint any part of battery, including any internal or external components.
- Do not connect battery with PV solar wiring directly.
- Do not install or use this product beyond provisions of the manual.
- Direct or indirect damages caused by the above reasons are not covered by warranty claim.

### 2.2 Before Connecting

- Please check the external packaging condition before unpacking. If it is damaged, contact corresponding local retailer.
- After unpacking, please check the products and spare parts according to spare parts list. If the product is damaged or missing, please contact your local retailer.
- The battery system should be installed with the specified matching inverter.
- Before installation, be sure to cut off the grid power and make sure battery is in turned-off mode.
- It is prohibited to connect the battery and AC power directly.

- Embedded BMS in the battery is designed for 24VDC.
- All electrical wiring must be connected in accordance with local regulations.
- Please ensure that electrical performance of battery system is compatible with the equipment used.
- The installation onsite shall be equipped with fire-fighting facilities that meet relevant requirements, such as fire sand, dry powder fire extinguisher, etc.
- Please don't mix old and new batteries.

### **2.3 In Using**

- If battery system needs to be moved or repaired, power must be cut off and battery is completely shut down.
- It is prohibited to connect battery with different types of battery.
- Do not connect battery to faulty inverter.
- In case of fire, only dry powder fire extinguisher can be used, liquid fire extinguishers are prohibited.
- Do not open, repair or disassemble the battery except WHES personnel or other authorized personnel. The company shall not bear any liability or responsibility caused by violation of any safety operation or design standard, production standard, equipment safety standards or any other standards or requirements.

### 3 INTRODUCTION

#### 3.1 Product Overview

Myrtillo is a new energy storage system, which consists of a high voltage box and battery expansion modules. It can store and release the electric energy according to the requirements of the solar energy storage system. The input and output ports of Myrtillo are high voltage direct current ports.

This manual contains important instructions for Myrtillo series high-voltage energy storage system that should be followed during installation and maintenance.

This manual applies to the listed system models below:

##### Myrtillo Series:

- WH-BXC4992-1S
- WH-BXC4992-2S
- WH-BXC4992-3S
- WH-BXC4992-4S
- WH-BXC4992-5S
- WH-BXC4992-6S

##### Model description

WH-BXC4992-2S

No.	Referring to	Description
1	Brand Code	WH: WEIHENG
2	Equipmet Type	BX: Battery Box
3	Version Code	C: Third version
4	One Battery Box Rated Capacity	4992: the battery box rated capacity is 4992Wh
5	System Composition	2S: Two battery boxes in series, 10kWh

#### 3.2 Features

- Cathode material is made from LiFePO4 with safety performance and long cycle life.
- The system can automatically manage charge and discharge state and balance voltage of each cell.
- Flexible configuration, multiple battery modules can be in serial or in parallel for expanding voltage and capacity.
- Built-in fire suppression system (FSS) to enhance the whole system security.

- Adopted self-cooling mode rapidly reduced system entire noise.
- Optional built-in intelligent heating module ensures that whole system can be charged and discharged at -20 °C.

### 3.3 Application Scenarios

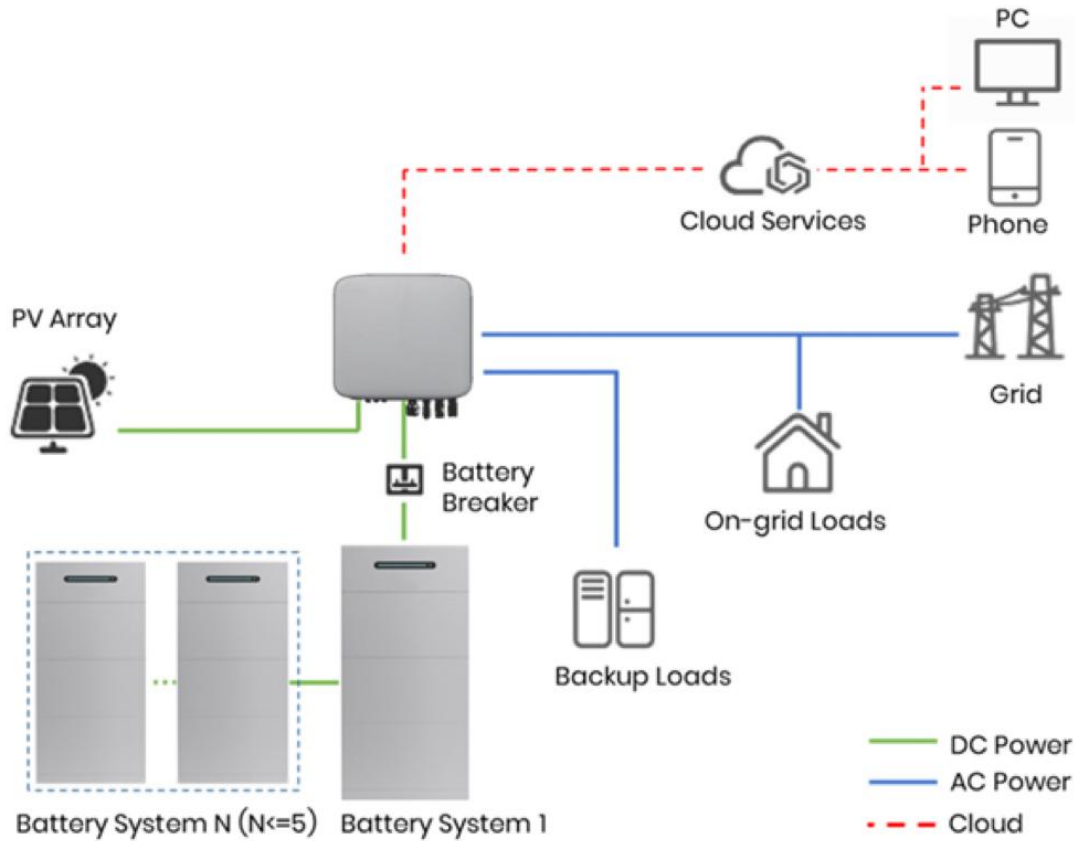

- **Battery System:** A max of five battery systems can be parallel connected in one energy storage system. Please refer to Myrtillo Approved Inverter Options Statement. Only inverters listed officially are allowed to be connected to Myrtillo Series.

### 3.4 Dimensions

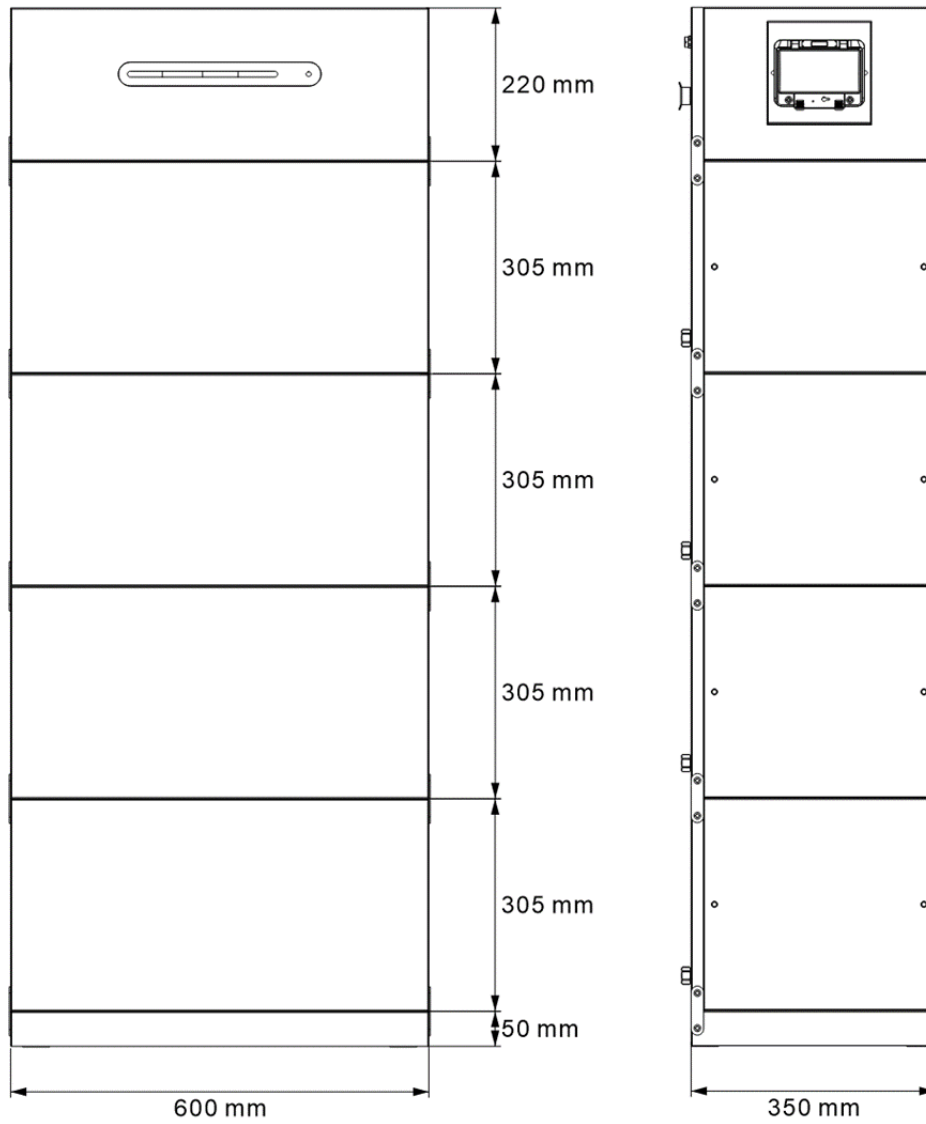

### 3.5 Indicator Status and Communication Port

- Battery system appearance

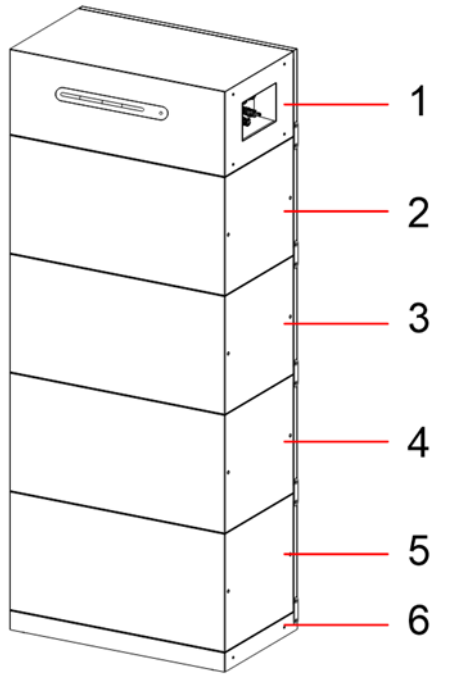

**NOTICE**

Ensure that the high voltage box is installed above the battery boxes. Do not install any battery box above the high voltage box .

This manual will show you the installation and electrical connection of 4 battery boxes.

NO.	Parts
1	High voltage box
2, 3, 4, 5	Battery box
6	Base

● Battery box appearance

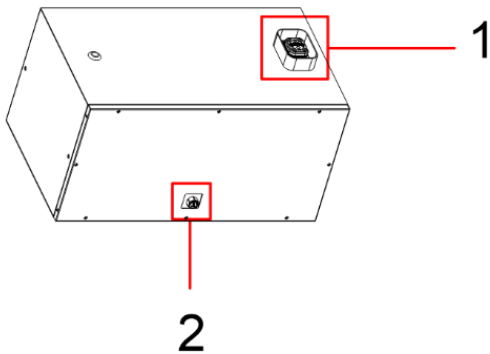

NO.	Parts
1	Guided quick connector
2	Leak valve

● Base appearance

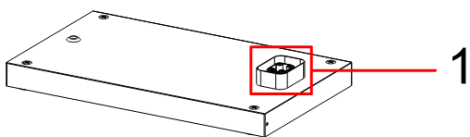

NO.	Parts
1	Guided quick connector
6	Base

● High voltage box appearance

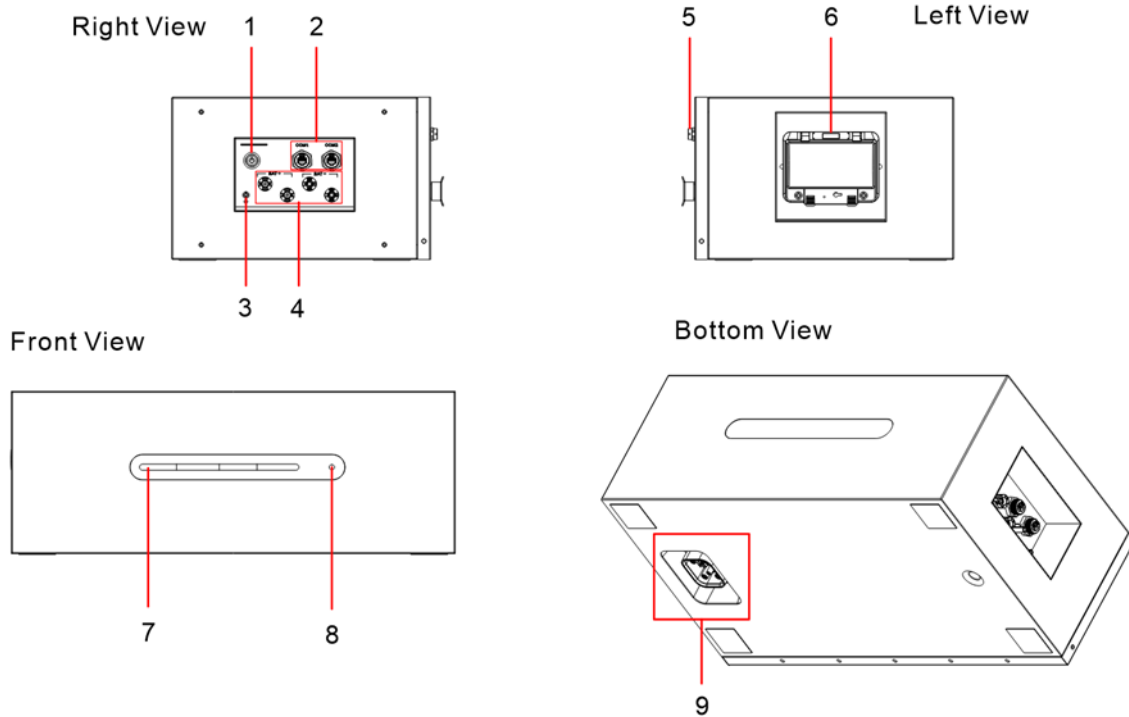





No.	Name	Definition
1	Multifunction button	<p>Black start mode: When there is no PV and grid, press and hold for 5 seconds to start the system and drive the inverter to work.</p> <p>Power off mode: When the system is powered on, press and hold for 5 seconds to turn off the system. If you hear a click, it means the system has been powered off. After turning off via this button, if you want to turn it on again, please press and hold the button for 5 seconds.</p> <p><b>Note</b> After the system is installed for the first time, there is no need to turn it on via this button. Please refer to Chapter 5.2 to turn it on via the DC breaker.</p>
2	Communication terminal(COM)	Be used to communicate with inverter or parallel operation
3	Grounding point	System ground connection
4	DC terminal (BAT)	Connect battery system with Inverter
5	Leak valve	Battery box safety protection device
6	DC breaker	The master switch of the battery system, you

		must switch on it before power on the system; Short circuit protection
7	SOC indicator	Please see the detail description below this section
8	Status indicator	Please see the detail description below this section
9	Guided quick connector	Battery module power and communication interface

**Run/Fault**





















Green LED lighting to show the battery system is Normal

Red LED lighting to show the battery system is Fault.



Status	Mode	Run/Fault	Remark
Power off	Power off		Light is off
Checking	System is initializing		1-Second intervals
Run	Standby/Charge/Discharge		Light is on
Fault	Fault		System is stopping, and check the problem

**SOC**

Blue LEDs are used to show the battery’s remaining capacity.

State		Charging/Discharging			
Capacity Indicator LED		L4	L3	L2	L1
SOC	SOC < 5%				
	5 ≤ SOC < 25%				
	25 ≤ SOC < 50%				
	50 ≤ SOC < 75%				
	75 ≤ SOC < 100%				

**Note**

-  The indicator light is flashing at 2s intervals.
-  The SOC indicator light is off.
-  The SOC indicator light is on.

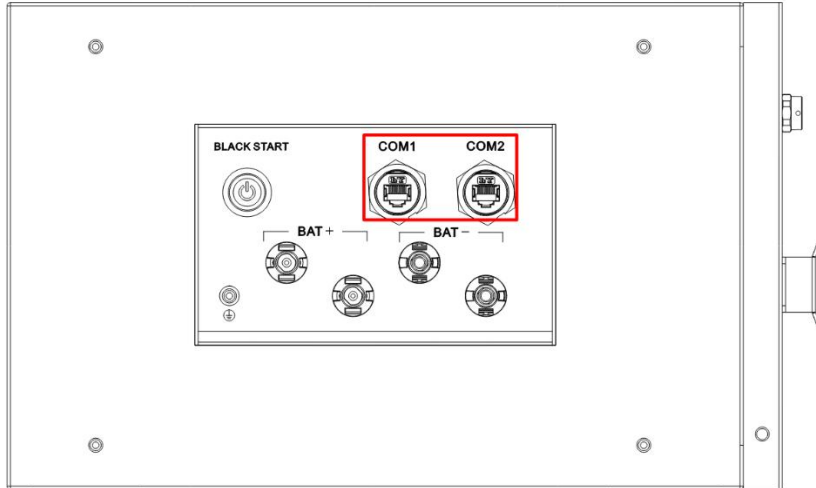

**COM1 RJ45 Socket**

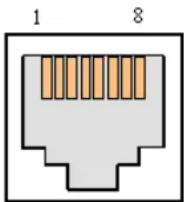

Pin	Definition
1	RS485A
2	RS485B
3	CANL
4	CANH
5	GND
6	Undefined
7	GND
8	GND

**COM2 RJ45 Socket**

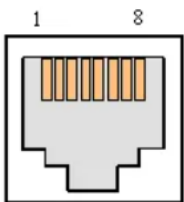

Pin	Definition
1	RS485A
2	RS485B
3	CANL
4	CANH
5	GND
6	Undefined
7	GND
8	GND

### 3.6 Product identity definition

High voltage box nameplate:

**eCACTUS**  
Rechargeable Li-ion Battery System

Model/Nominal Voltage/ Energy/Operating Voltage Range	
<input type="checkbox"/>	WH-BXC4992-1S/96Vdc/4.99kWh/84~108V
<input type="checkbox"/>	WH-BXC4992-2S/192Vdc/9.98kWh/168~216V
<input type="checkbox"/>	WH-BXC4992-3S/288Vdc/14.9kWh/252~324V
<input type="checkbox"/>	WH-BXC4992-4S/384Vdc/19.9kWh/336~432V
<input type="checkbox"/>	WH-BXC4992-5S/480Vdc/24.9kWh/420~540V
<input type="checkbox"/>	WH-BXC4992-6S/576Vdc/29.9kWh/504~648V
HV Box Model	HBC571
Capacity	52Ah
Ingress Protection	IP65
Operating Ambient Temperature	-20°C~55°C
Nominal Charge/Discharge Current	26A
Max. Charge/Discharge Current	52A
Protective Class	I



Jiangsu Weiheng Intelligent Technology Co.,Ltd.  
Address: Sheng Xiang Yaxi Community, Luoshe Town, Huishan District, 214000, Wuxi City, Jiangsu Province  
[www.weiheng-tech.com](http://www.weiheng-tech.com) Made in China

Battery box nameplate:

**eCACTUS**

---

**Rechargeable Li-ion Battery**  
 IFpP/13/122/360/[30S]M/-20+55/95  
 Rated Capacity:52Ah  
 Model No./Nominal Voltage/Rated Energy :  
 WH-BXC4992/96Vd.c./4.992kWh  
 Max.Charge/Discharge Current:52A  
 Nominal Charge/Discharge Current:26A  
 Operating voltage range:84V...108V  
 Operating temperature range:  
 0°C...+50°C(Charge),-20°C...+55°C(Discharge)  
 Available SOC Range:10%...100%  
 Protective Class:I  
 IP Class:IP65



The battery should be disposed by qualified recycling agent.

 **CAUTION**

- Do not disassemble the battery pack.
- Do not immerse the battery pack in water.
- Do not short-circuit the battery.
- Do not leave the battery near by fire.

**Emergency Situations**

- \* If leaking ,fire, wet or damaged ,switch off the breaker and go away from the battery.
- \* Do not touch the leaking liquid .Do not use water.Sand or dry powder extinguisher is usable.







Manufacturer:Jiangsu Weiheng Intelligent Technology Co., Ltd.  
Made in China

### 3.7 Technical Data

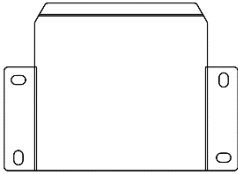

Model	WH- BXC4992- 1S	WH- BXC4992- 2S	WH- BXC4992- 3S	WH- BXC4992- 4S	WH- BXC4992- 5S	WH- BXC4992- 6S
Battery Type	LFP					
Battery Module	4.992kWh, 96V					
Number of Modules	1	2	3	4	5	6
Nominal Capacity/kWh	4.992	9.984	14.976	19.968	24.86	29.952
Nominal Voltage/V	96	192	288	384	480	576
Operating Voltage/V	84...108	168...216	252...324	336...432	420...540	504...648
Recommend Charge/Discharge Current/A	26					
Max. Charge/Discharge Current	52					
Depth of Discharge	90%					
Display	SOC indicator, Status indicator					
Communication Interface	CAN, RS485					
Dimensions(W*D*H)/mm	600*350*575	600*350*880	600*350*1185	600*350*1490	600*350*1795	600*350*2100
Weight/kg	69	126	183	240	297	354
Installation	Indoor/Outdoor, Floor stand					
Cooling Method	Natural convection					
Operating Temperature Range/°C	-20...+55					
Ingress Protection	IP65					
Allowable Relative Humidity Range	5...95%					
Max. Operating Altitude	Max. 3000m					
Certificates	IEC 62619, IEC 63056, IEC 62040, IEC 61000, UN38.3					

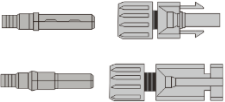
## 4 INSTALLATION

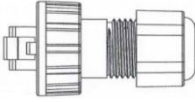
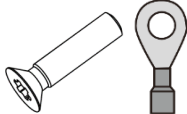
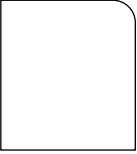
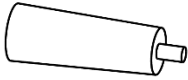
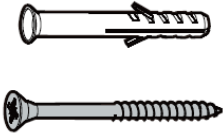
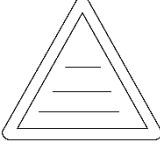
### 4.1 Packing List

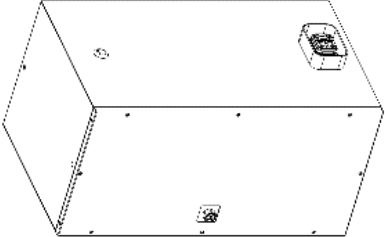
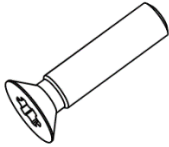
WH- High Voltage Box + WH-Base			
			
1 × High Voltage Box 1 × Base		1 × Locking Bracket	2 × Sheet Metal Brackets
			
1 × Positive DC Connector 1 × Negative DC Connector	1 × Quick Installation Guide	1 × RJ45 Connector	4 × M5*12 Screws 1 × OT5-5 Terminal
			
1 × Warranty Card	4 × Plastic Handles	4 × $\phi 10*60$ Expansion Bolts	1 × Qualified Certificate

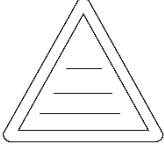
WH- Battery Box	
	

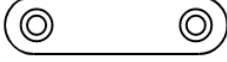
1 × Battery Box		4 × M5*12 Screws
		
1×Qualified Certificate	4 ×Rubber Stoppers	2 × Sheet Metal Brackets

## 4.2 Installation Location and Environment

### 4.2.1 General

Install the equipment on a surface that is solid enough to bear the product weight. Please evaluate the load-bearing capacity. The installation location should be well-ventilated and away from flammable or explosive materials.

This battery box is rated for outdoor installation and can be installed both indoors and outdoors. The battery box is naturally ventilated. The installation location must be clean, dry, and adequately ventilated. Enough space should be left for unrestricted access to the unit for installation and maintenance purposes, and the system panels should not be obstructed.

The battery system should not be installed in the following locations:

- ◆ Habitable rooms;
- ◆ Ceiling or wall cavities;
- ◆ On roofs not suited for the purpose;
- ◆ Access/exit areas or under stairs/access passages;
- ◆ Places where freezing temperatures can occur, such as garages, carports, or other places such as wet rooms;
- ◆ Humid or salty environments;
- ◆ Seismic-prone areas—additional safety measures are needed;
- ◆ Sites higher than 2000 meters above sea level;
- ◆ Explosive atmospheres;
- ◆ In direct sunlight or places susceptible to significant changes in ambient temperature.

## 4.2.2 Location Restrictions

The battery system should not be installed:

- (1) Within 600 mm of any heat source, such as hot water units, gas heaters, air conditioning units, or any other similar appliances;
- (2) Within 600 mm of any exit;
- (3) Within 600 mm of any window or ventilation opening;
- (4) Within 900 mm of access to 120/240 VAC connections;
- (5) Within 600 mm of the side of any other device.

Leave at least 1 meter of clearance between the battery box and any emergency exits when installing the device in corridors, lobbies, or hallways to ensure a safe exit.

## 4.2.3 Barriers to Habitable Rooms

Ensure a suitable non-combustible barrier is set up between the battery box and any installation walls or structures when installing the battery box on a wall or structure connected to a living space to protect against the spread of fire to living spaces. A non-combustible barrier should be installed between the battery box and the surface of the wall or structure it is being mounted to if the surface itself is not made out of a suitable non-combustible material. Increase the distance between the battery box and any other nearby structures or objects if there is less than 30 mm between the battery box and the wall or structure separating it from living spaces.

The following spaces around the battery box must remain empty:

Top	-----	500 mm
Bottom	-----	500 mm
Front	-----	500 mm
Left and right sides	-----	500 mm

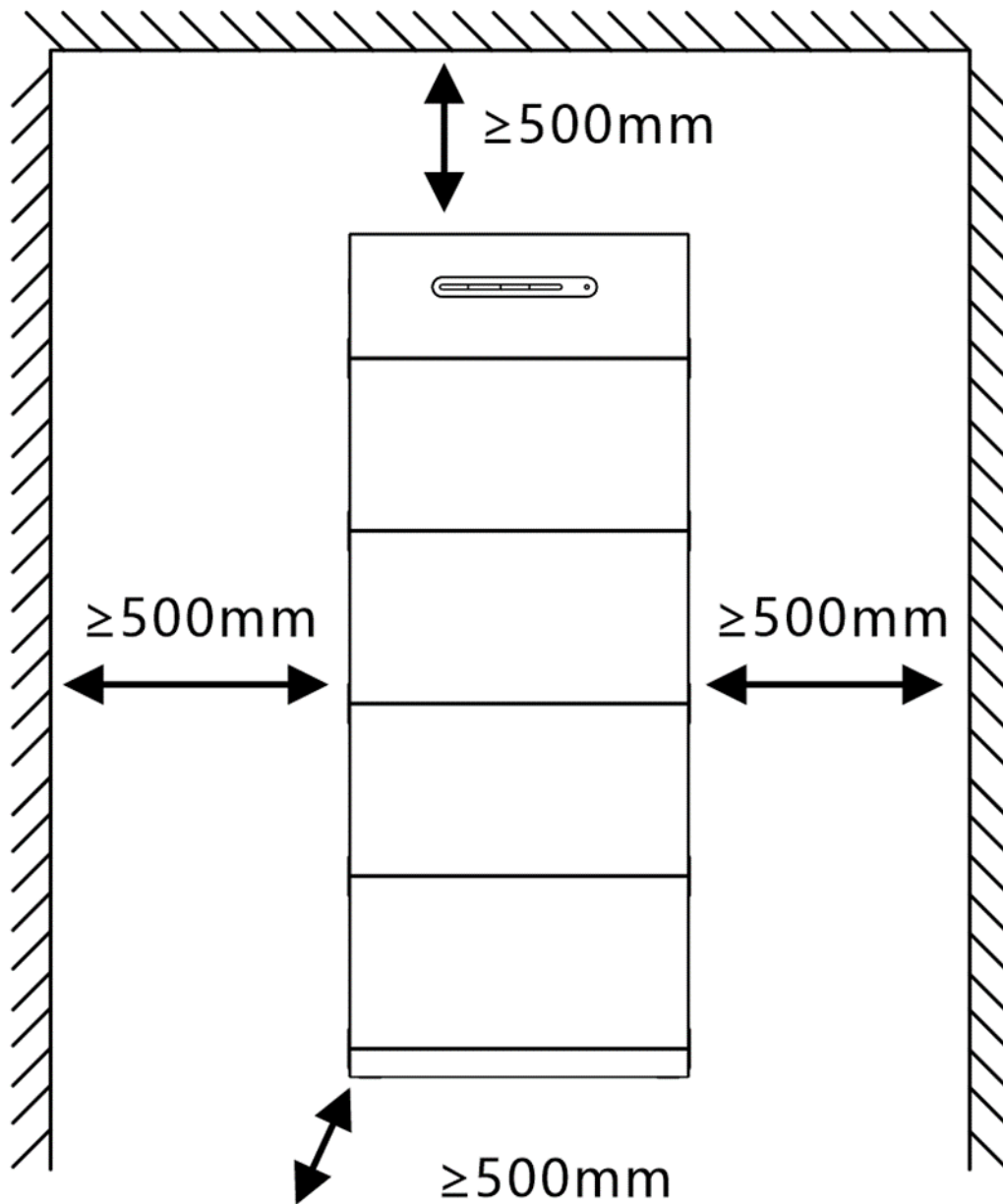

### 4.2.4 Choosing an Installation Location

**NOTICE**

Carefully select an appropriate installation location based on the following rules to protect the Battery Box and facilitate maintenance.

**Rule 1.** Do not install the system at forward tilted, back tilted, side tilted, horizontal, or upside down positions.

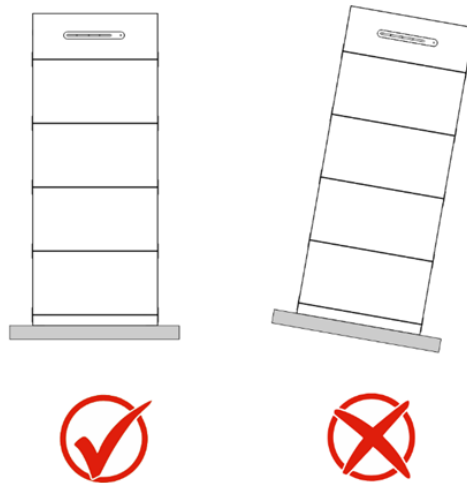

**Rule 2.** Install the system on a solid brick-concrete structure or concrete wall or floor. If other types of walls and floors are used, they must be made of fire-retardant materials and meet the load-bearing requirements of the equipment.

**Rule 3.** During installation, ensure that there is no other equipment (except related Weiheng equipment and awnings) or flammable or explosive materials around the system. Reserve sufficient clearances for heat dissipation and safety isolation.

**Rule 4.** The temperature and humidity at the installation site should be within the appropriate range.

**Rule 5.** The system installation location should be protected from direct sunlight or bad weather like snow, rain, or lightning.

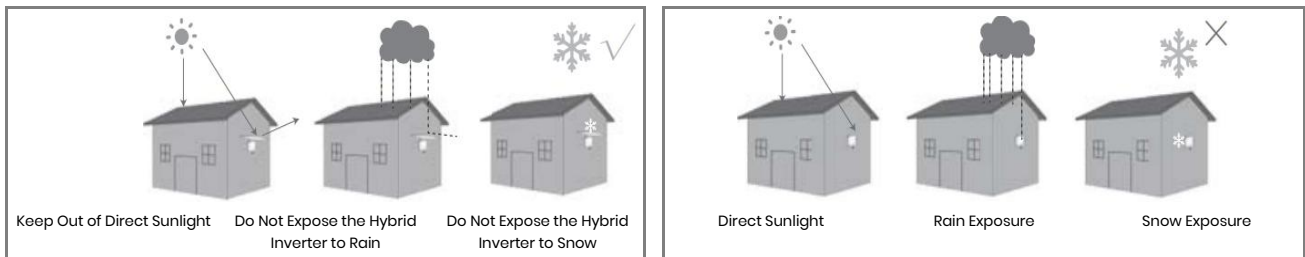

**Rule 6.** Installing the system at eye level will make maintenance more convenient.

**Rule 7.** Install the system at least 500 meters away from the coast and avoid sea breeze directly hit.

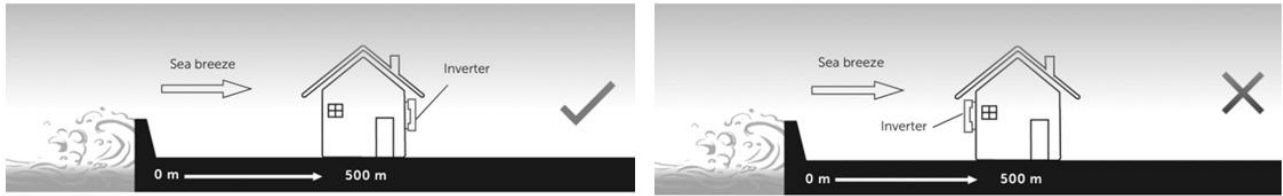

**Rule 8.** The product label should be clearly visible after installation.

**Rule 9.** Do not install the system in the snow or rain. If installation in the snow or rain is unavoidable, ensure the system and distribution box are protected and kept dry.

Install the system away from strong magnetic fields to avoid electromagnetic interference. When installing the system next to radio or wireless communication equipment operating below 30 MHz: 1. Install the system at least 30m away from the wireless equipment. 2. Attach a low-pass EMI filter or a multi-winding ferrite core to the system DC input cable or AC output cable.

### 4.3 Installation Steps

**WARNING**

The system must not be installed near flammable or explosive materials or near equipment with strong electromagnetic fields.

The system should only be installed on concrete or other non-combustible surfaces.

Installation Tools:

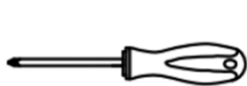

Screwdriver



Multimeter



Wire stripper

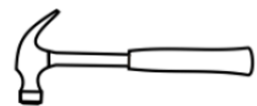

Claw hammer

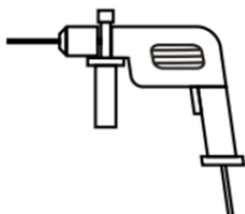

Hammer drill



Diagonal plier

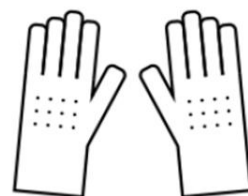

Insulating gloves

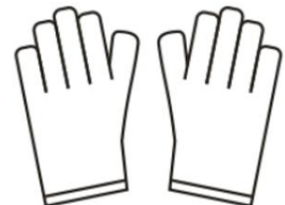

Protective gloves

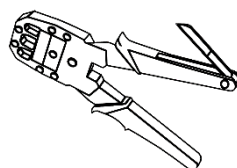

## Crimping pliers

**CAUTION**

- Follow local electric safety and installation policy, a suitable breaker between battery system and inverter is required.
- All installation and operation must follow local electric standard and requirements.
- When battery modules are paralleled, the system should be powered off before installation operation.

**Step1:** Take out the high voltage box and base from the package.

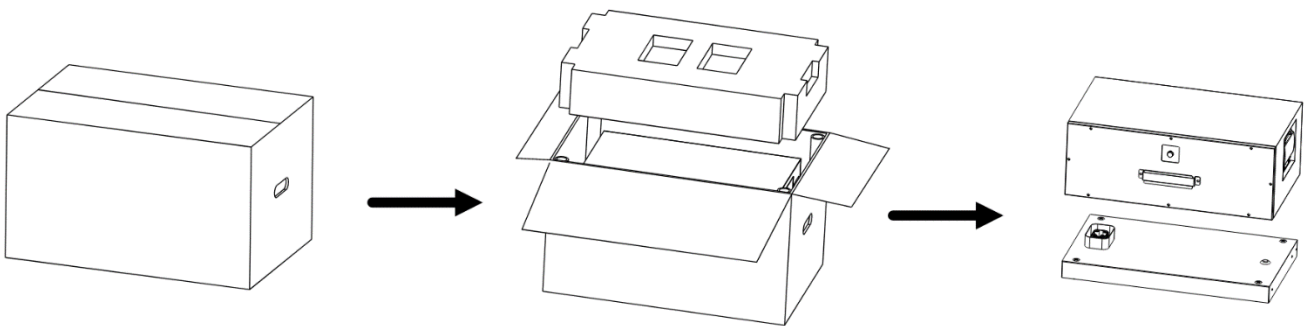

**Step2:** Place the base on the ground and adjust the height of the bottom support leg with a screwdriver to ensure that the base is horizontal.

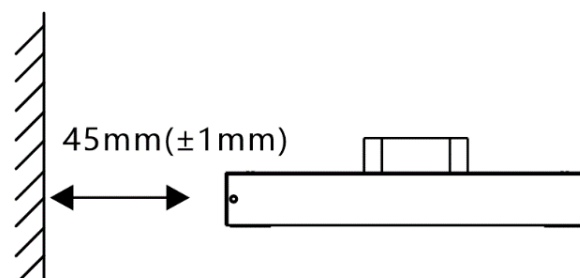
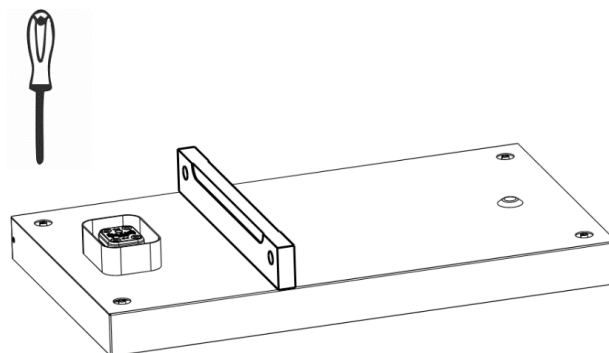

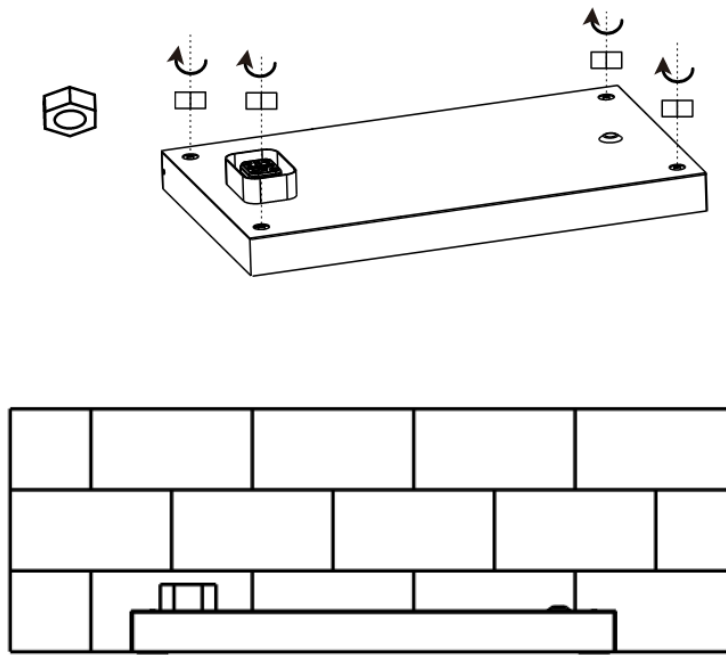

**Step3:** Install the wall-hanging plate of the high voltage box.

Drill a hole with a diameter of 10mm at the center of the waist-type hole in the back plate with the electric drill and Place the plastic expansion tube, then fix the self-tapping screw with a screwdriver. The electric drill must with a dust cover to prevent dust from falling off.

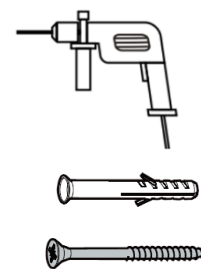
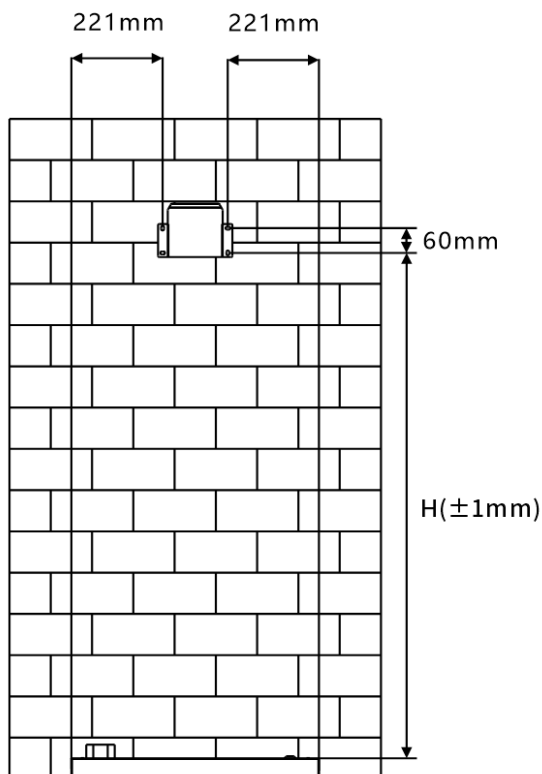

n	H(mm)
1	293.5
2	599
3	904.5
4	1210
5	1515.5
6	1821

**Step4:** Take out the battery box from the package

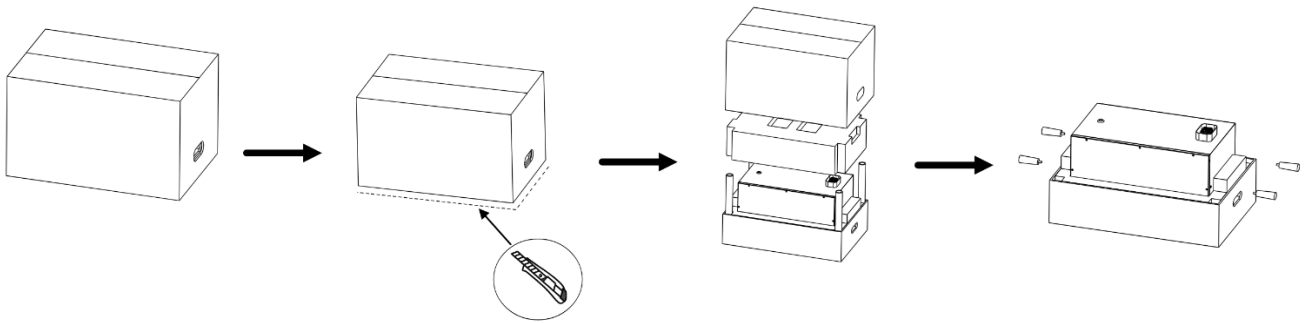

**CAUTION**

- Be cautious to prevent injury when moving heavy objects. (The weight of an Energy Storage Module is 65 kg)
- Use lifting handles to move an energy storage module. Do not move it directly with your hands.
- Ensure that the plastic handles are securely connected to the energy storage module, with the steel washers of the plastic handles closely fitted to the energy storage module. Do not lift the energy storage module before the plastic handles are tightened.
- The lifting handles are auxiliary moving tools and not applicable to long-distance transportation.
- Do not use a damaged lifting handle. If the stud of a lifting handle is bent, replace the plastic handle promptly.

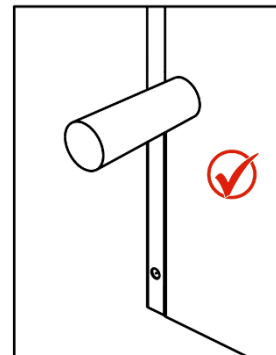
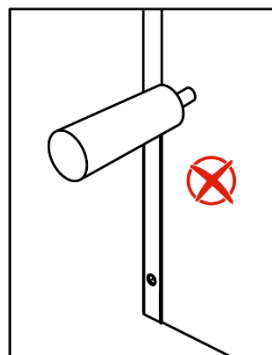
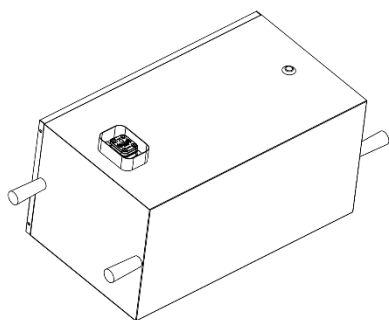

**Step5:** Install the first battery box, mstack the battery box, on the base, Fix the sheet metal brackets on both sides with screws.

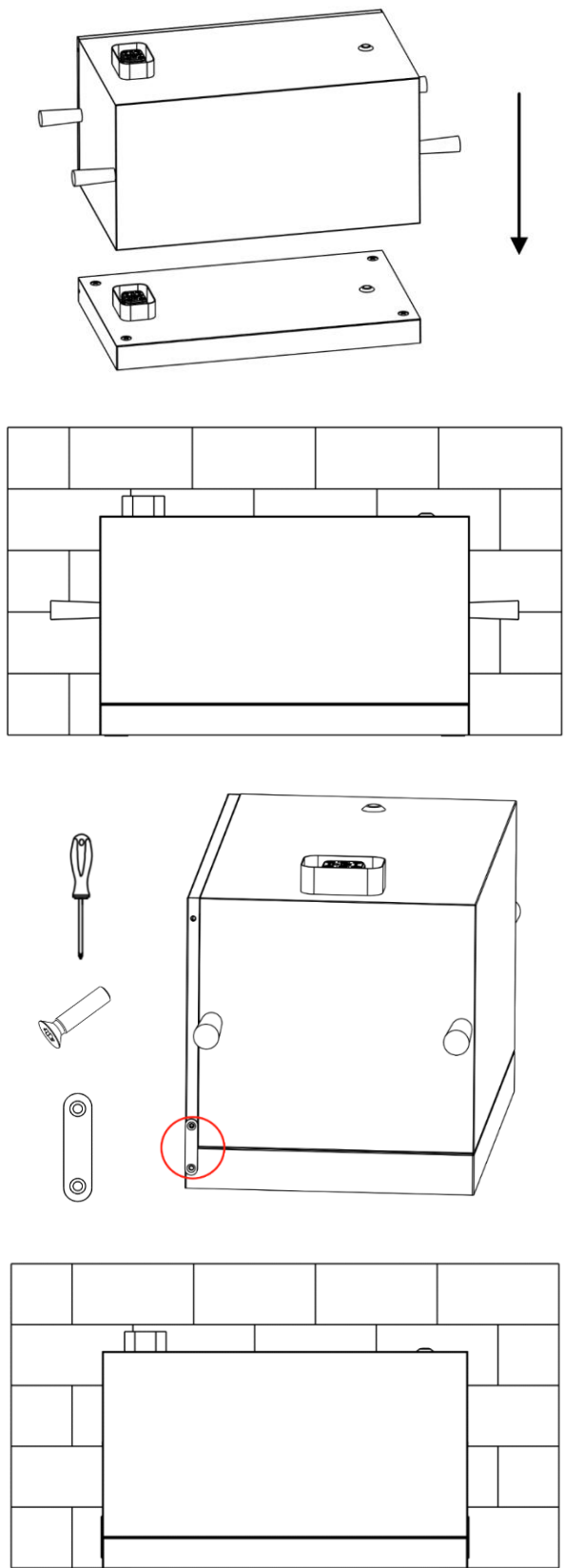

**Step6:** Install all the battery boxes in turn, fix the sheet metal brackets on both sides, and finally put the back plate of the high voltage box into the locking bracket and fix the sheet metal brackets on both sides.

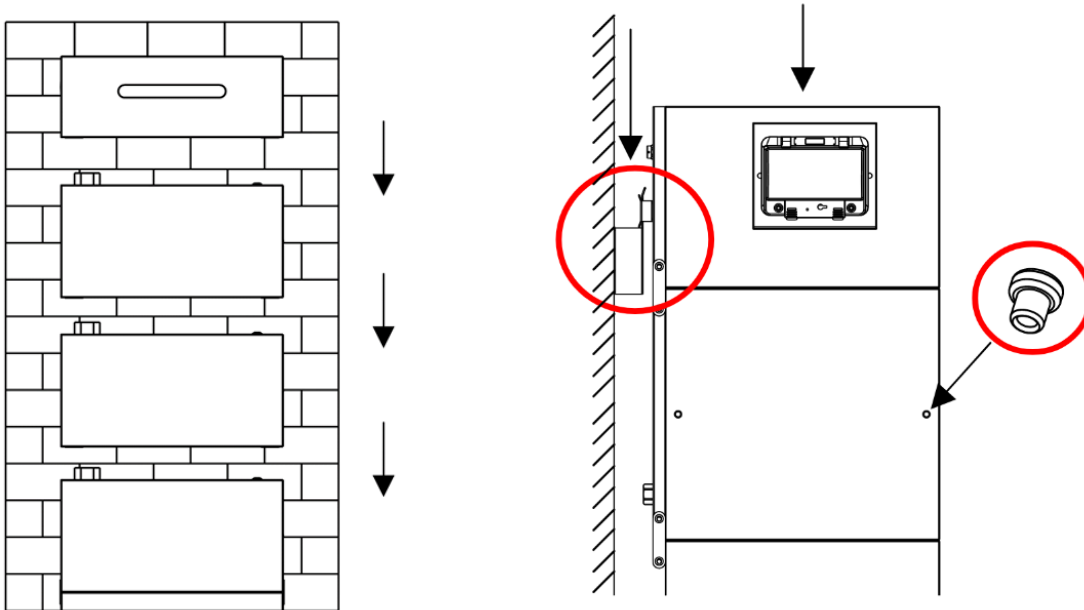

**⚠ CAUTION**

- If multiple persons need to move the battery box together, determine the manpower and work division with consideration of height and other conditions to ensure that the weight is equally distributed.
- If two persons or more move the battery box together, ensure that the battery box is lifted and landed simultaneously and moved at a uniform pace under the supervision of one person.
- Wear personal protective gears such as protective gloves and shoes when manually moving the equipment.
- To move the battery box by hand, approach to the battery box, squat down, and then lift the battery box gently and stably by the force of the legs instead of your back. Do not lift it suddenly or turn your body around.
- Do not quickly lift the battery box above your waist. Place the battery box on a workbench that is half-waist high or any other appropriate place, adjust the positions of your palms, and then lift it.
- Move the battery box stably with balanced force at an even and low speed. Put down the battery box stably and slowly to prevent any collision or drop from scratching the surface of the equipment or damaging the components and cables.
- When moving the battery box, be aware of the workbench, slope, staircase, and slippery places. When moving the battery box through a door, ensure that the door is wide

enough to move the battery box and avoid bumping or injury.

- When transferring the battery box, move your feet instead of turning your waist around. When lifting and transferring the battery box, ensure that your feet point to the target direction of movement.

**Step7 :** Connect the ground cable, power cable and communication cable between PCS and battery rack.

- **Power cable** connection process is as below:

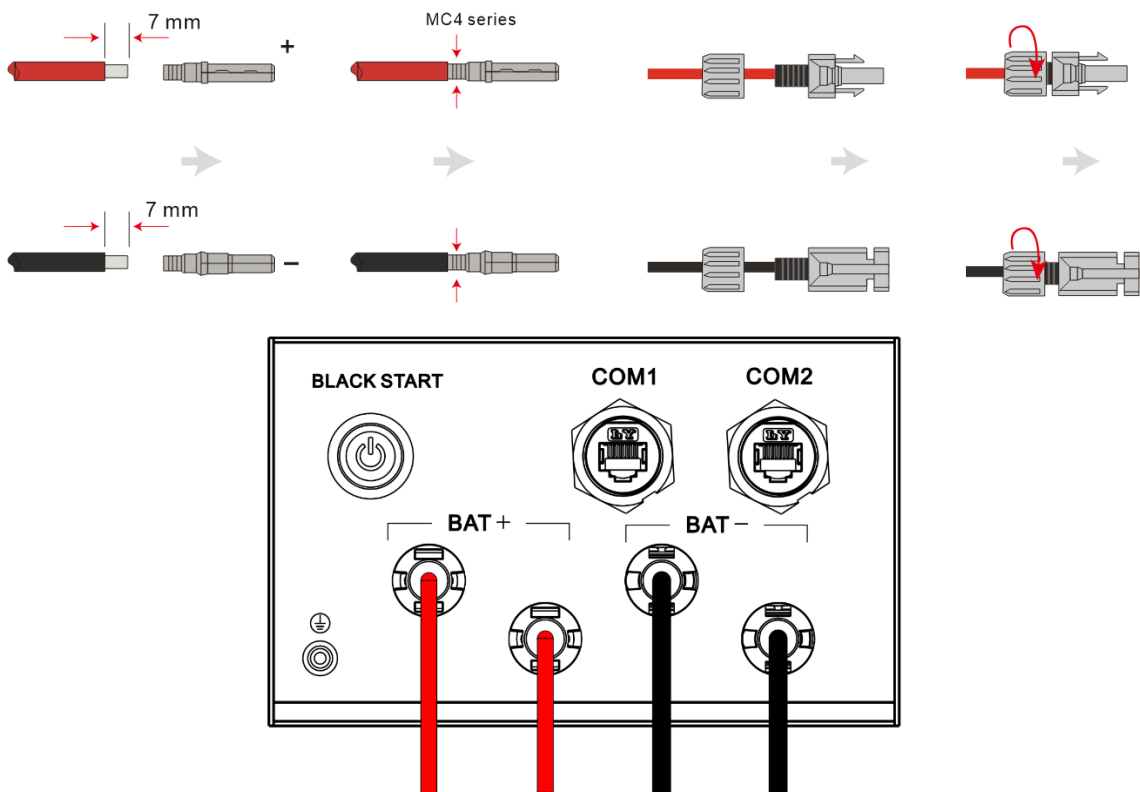

- **PE cable** connection process is as below:

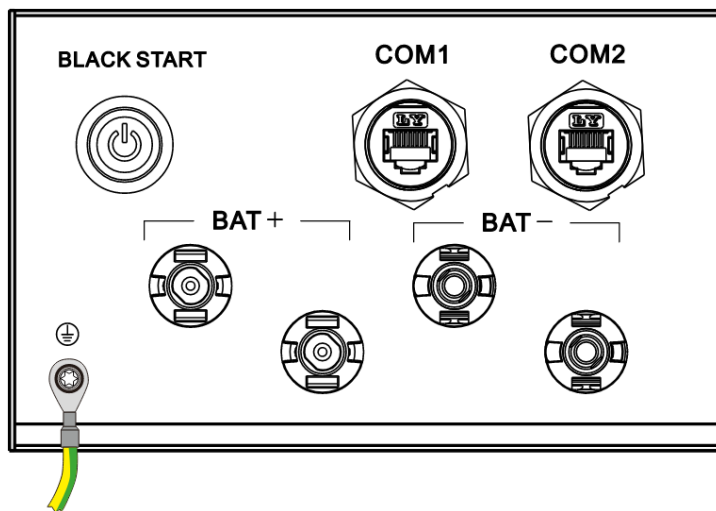
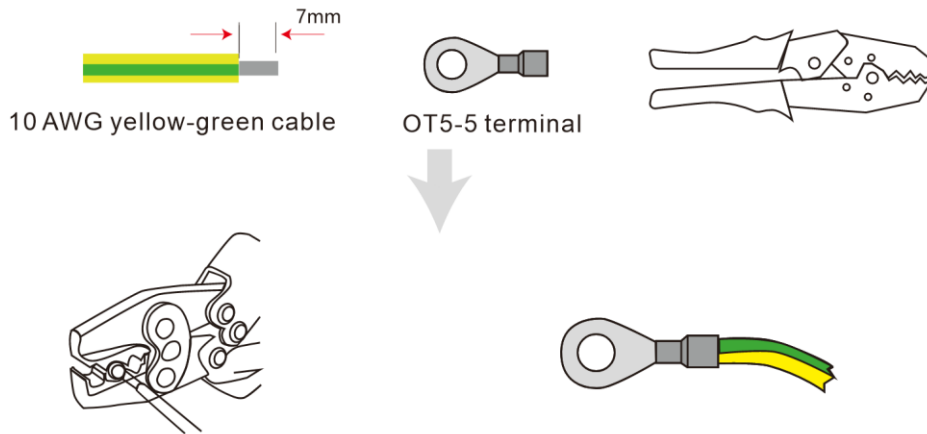

**NOTICE**

Ground cable shall be connected to ground plate on grid side this prevents electric shock. if the original protective conductor fails.

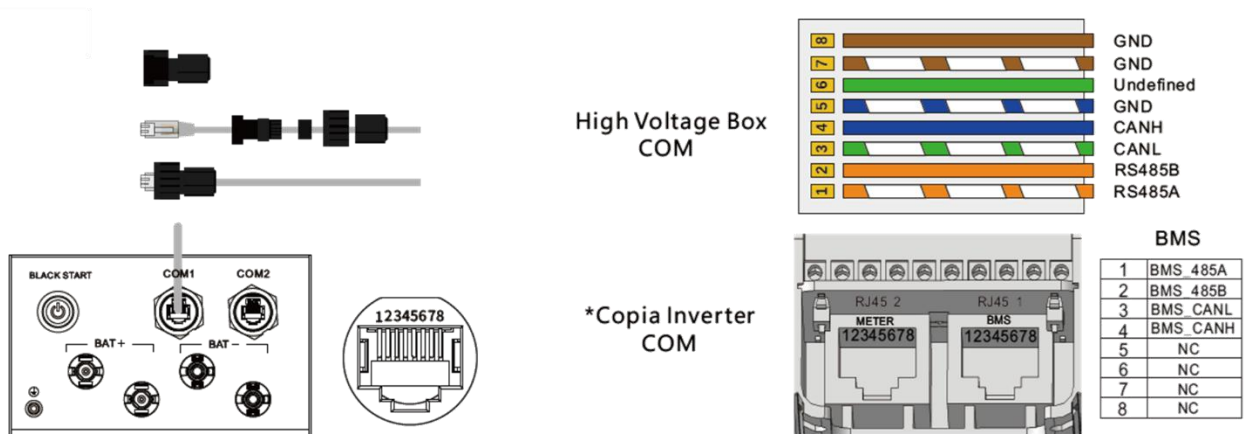

For third-party inverters, please refer to the COM port definition in the user manual for wiring.

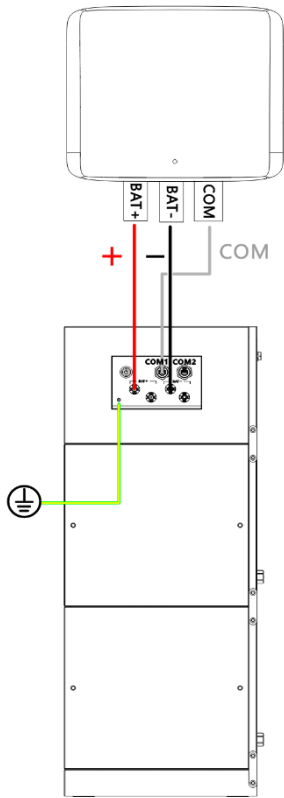

Cable Type	Cable Specification	Cable Area
BAT+/BAT-	8AWG	8.37mm <sup>2</sup>
PE	10AWG	5.26mm <sup>2</sup>

\*This is the recommended minimum wire diameter, please select the wire diameter according to the actual installation situation.

## 5 System Operation

### 5.1 Check Before Turning ON

Please check the following before turning on to avoid the battery system being damaged.

No.	Check Item
1	Double check the power cable, communication cable, PE cable are connected correctly and securely.
2	Make sure the voltage of the inverter/PCS is same level with the battery system before connection.
3	Unused ports and terminals are sealed.

### 5.2 Turn ON the Battery System

#### NOTICE

The DC breaker between the inverter and the battery, and between the two batteries (parallel solution), shall be installed in accordance with local laws and regulations.

**Step1:** If necessary, turn on the breaker between the inverter and the battery system.

**Step2:** Open protect cover of the DC breaker (Pic1). And turn on the DC breaker (Pic2).

**Step3:** Turn on the inverter in the system following the user manual of the inverter.

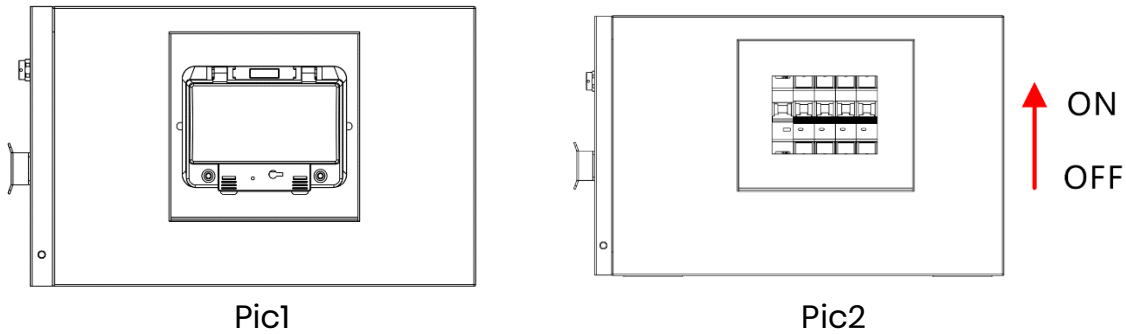

### 5.3 Parallized battery systems

**Step1:** If necessary, turn on the breaker between the inverter and the battery system.

**Step2:** Turn on the breakers between the battery systems.

**Step3:** Open protect cover of the DC breaker. And turn on the DC breaker in turn.

**Step4:** Turn on the inverter in the system following the user manual of the inverter.

### 5.4 Turn off the Battery System

When failure or before service, must turn the battery storage system off:

**Step1:** Turn off the inverter or power supply on DC side.

**Step2:** Turn off the switch between PCS and battery system.

**Step3:** Open protect cover of the DC breaker. Switch the DC breaker to off position. (Switch off the slave battery system firstly, finally switch off the master battery system)

#### NOTICE

- One battery system shall just have one maste, all the others are slaves. The one on the extreme side connected to inverter is the master battery.
- It is forbidden to switch off the Isolating Switch during charging and discharging.

## 6 Emergency Situations

### 6.1 Battery Leakage

If the battery pack leaks electrolyte, avoid contact with the leaking liquid or gas. If one is exposed to the leaked substance, immediately perform the actions described below

- 1) Inhalation: Evacuate contaminated area and seek medical aid.
- 2) Contact with eyes: Rinse eyes with flowing water for 15 minutes and seek medical aid.
- 3) Contact with skin: Wash affected area thoroughly with soap water and seek medical aid.

Ingestion: Induce vomiting and seek medical aid.

### 6.2 On Fire

**⚠ DANGER**

DO NOT USER WATER. Only dry powder fire or carbon dioxide extinguisher can be used; if possible, move the battery module to a safe area before it catches fire.

### 6.3 Wet Batteries

If the module is wet or submerged in water, do not let people access it, then contact WHES or an authorized dealer for technical support. Cut off all power switch on inverter side.

### 6.4 Damaged Batteries

Damaged batteries are dangerous and must be handled with utmost care. They are not fit for use and may pose a danger to people or property. If the module seems to be damaged, pack it in its original container, then return it to authorized dealer.

**⚠ DANGER**

Damaged batteries may leak electrolyte or produce flammable gas. Never try to repair the damaged batteries even if you are a qualified electrician.

## 7 Remarks

### 7.1 Recycle and Disposal

In case a battery (normal condition or damaged) needs disposal or needs recycling, it shall follow the local recycling regulation (i.e. Regulation (EC) N° 1013/2006 among European Union) to process, and using the best available techniques to achieve a relevant recycling efficiency.



### 7.2 Maintenance

- 1) It is required to charge the battery at least once every 6 months, for this charge maintenance make sure the SOC is charged to higher than 85%.
- 2) Check installation environment such as dust, water, insect etc. Make sure it is suitable for IP65 battery system. Connection of power connector, grounding point, power cable and screw are suggested to be checked every year

### 7.3 Declaration of conformity

The battery system described in this document complies with the applicable European directives. The certificate is available in the download area of our websites.