

OPERATION AND MAINTENANCE MANUAL

<https://www.kon-tec.eu/>

LOW VOLTAGE ENERGY STORAGE KON-TEC
LITHIUM IRON PHOSPHATE LiFePO₄

51,2V 100Ah

KT-LFPES512100



LEGAL PROVISIONS

This manual describes in detail the requirements and procedures for safe installation and operation of Kon-TEC lithium battery pack. Please read this manual carefully, only qualified persons are allowed to install, operate and maintain the system, otherwise it may cause product damage or personal safety risks.

Any actions against safety operation, or do not follow rules of this manual and limited warranty letter, will void warranty and qualification of this product. Meanwhile, the manufacturer will be not responsible for the product damage, property damage, personal injury or even death.

The information contained in this manual is accurate when it's issued. Kon-TEC reserve right to change specification (such as optimization, upgrade or other operations) without prior notice, please always view the latest document via QR code. In addition, please noted that the diagrams/schematics in this document are used to help understand system configuration and installation instructions, which may be different from the actual items at the installation.

LEGAL TERMS

Kon-TEC will retain the copyright of this document, do not extract, copy or translate in any ways without the written permission.

ON-LINE INSTRUCTIONS IN POLISH AND ENGLISH

You can find online instructions in Polish and English on our website www.kon-tec.eu. In the 'Energy Storage' section, select the appropriate product, then go to the 'Download' tab.

CONTENT

1. Information.....	2	4.2 Inspection.....	10
1.1 Validity.....	2	4.2.1 Unpacking.....	10
1.2 Target Group.....	2	4.2.2 Scope of delivery.....	10
1.3 Levels of warning messages.....	2	4.2.3 External cable kits.....	14
1.4 Symbol Description.....	2	4.3 Start Installation.....	15
1.5 Abbreviation Description.....	3	4.3.1 Remainder.....	15
2. Safety.....	3	4.3.2 Procedures.....	15
2.1 Safety precautions.....	3	4.3.2.1 Rack mounted.....	16
2.2 Safety instructions.....	4	4.3.2.2 Stack mounted.....	16
2.2.1 Safety gear.....	4	4.3.2.3 Wall mounted.....	17
2.2.2 Emergency safety measures.....	4	4.3.2.4 Floor mounted.....	18
2.2.3 Other Tips.....	4	4.3.3 Tips.....	19
3. Product Overview.....	5	5.5. Cable connection and commissioning.....	20
3.1 Introduction.....	5	5.1 Get battery ready.....	20
3.2 Features.....	5	5.2 Grounding cable connection.....	20
3.3 Specification.....	6	5.3 Communication cable connection.....	20
3.3.1 Dimension.....	6	5.4 DC power cable connection.....	21
3.3.2 Parameters.....	6	5.5 Connecting with inverter.....	22
3.3.3 Panel Interface.....	7	5.6 Commissioning.....	26
3.4 Protection function.....	9	5.7 Switch off battery.....	26
4.4 Installation.....	10	6. Troubleshooting and FAQ.....	27
4.1 Preparation.....	10	7. Transport, Storage.....	27
4.1.1 Safety Compliance.....	10	8. Disposal of battery.....	27
4.1.2 Environment.....	10	9. Appendix - inverters / chargers connections.....	28
4.1.3 Tools.....	10		

1. INFORMATION

1.1 VALIDITY

This document is valid for: KT-LFPES512100 Battery Pack.

1.2 TARGET GROUP

This document is intended for qualified persons and operators. Only qualified persons are allowed to perform the activities marked in this document with a warning symbol and the caption „Qualified person”. Qualified persons must have the following skills:

- Knowledge of how lithium iron phosphate batteries work and are operated.
- Knowledge of how an energy storage system (including PV/battery/hybrid inverter, MPPT, Meter, Distribution box etc.) works and is operated.
- Knowledge of local applicable connection requirements, standards, and directives.
- Training in the installation and commissioning of electrical devices, batteries.
- Training in how to deal with the dangers and risks associated with installing, repairing and using electrical devices, batteries.

1.3 LEVELS OF WARNING MESSAGES



The following levels of warning messages may occur when handling the product

 DANGER
Indicates a hazardous situation which, if not avoided, will result in death or serious injury.
 WARNING
Indicates a hazardous situation which, if not avoided, could result in death or serious injury.
 CAUTION
Indicates a hazardous situation which, if not avoided, could result in minor or moderate injury or product permanent damage.
 NOTICE
Indicates a situation which, if not avoided, can result in property damage or product not work or accelerated product damage

1.4 SYMBOL DESCRIPTION

1.4.1 SYMBOLS ON PRODUCTS LABEL

LABEL	DEFINITION
	Beware of electrical shock
	Do not place the battery within children/pet touchable area.
	Do not place the battery near heat source and flammable material
	Do not expose the battery to direct sunlight, rain and snow.
	Do not short circuit the battery

LABEL	DEFINITION
	Certyficate CE
	Recycling sign

LABEL	DEFINITION
	WEEE designation

1.4.2 OTHER SYMBOLS

LABEL	DEFINITION
 Qualified person	Indicates activities that can only be performed by qualified persons

LABEL	DEFINITION
	Grounding point

1.5 ABBREVIATION DESCRIPTION

ABBREVIATION	DEFINITION
Battery/battery pack/ battery module	Single KT-LFPES512100 rechargeable lithium iron phosphate battery pack including cells, BMS and enclosure etc.
Battery system/cluster	Multiple KT-LFPES512100 battery pack connected in parallel with power, communication and grounding cables and installation auxiliaries.
BMS	Battery management system. Electronical Unit to ensure lithium cells' safety and display information or control the battery work mode.
SOC	State of charge. The battery state of charge refers to the percentage of the remaining capacity and rated capacity of the battery.
SOH	State of health. The battery health status refers to the percentage between the full charged capacity and the rated capacity of the battery.
DIP switch	Dual in-line package switch
COCP	Charge over current protection
DOCP	Discharge over current protection
COVP	Cell over voltage protection
POVP	Pack over voltage protection
CHTP	Charge high temperature protection
DHTP	Discharge high temperature protection
CUVP	Cell under voltage protection
PUVP	Pack under voltage protection
CLTP	Charge high temperature protection
DLTP	Discharge high temperature protection
SCP	Short circuit protection

2. SAFETY

2.1 SAFETY PRECAUTIONS

 **DANGER**

Explosion risk
 Donot impact the battery with heavy objects.
 Donot squeeze or pierce the battery pack.
 Donot throw the battery pack into the fire.

 **WARNING**

Fire risk
 Donot expose the battery pack to the condition over 80°C.
 Donot put the battery near a heat source, such as a fireplace.
 Donot expose the battery pack to direct sunlight or raining.

**CAUTION**

Electric shock risk
Donot allow non-qualified person to disassemble the battery pack.
Donot touch the battery pack with wet hands.
Donot expose the battery pack to moisture or liquid environment.

**NOTICE**

Damage risk
Donot short-circuit or reverse connect the battery.
Donot use chargers or charging devices unapproved by the manufacturer to charge the battery.
Donot mix batteries from different manufacturers or different kinds, types or brands.

2.2 SAFETY INSTRUCTIONS

The battery has been designed and tested in accordance with international (such as UL, IEC, UN38.3 etc.) safety requirements. However, due to various factors during the whole lifetime process, Kon-TEC cannot guarantee absolute safety, in order to prevent personal injury and property damage and ensure long-term operation of the battery, please do read the below section carefully to operate the battery and handle emergency situations.

2.2.1 SAFETY GEAR

It is required to wear the following safety gear when installing and handling the battery pack.



Insulated gloves



Safety Glasses



Safety Shoes

2.2.2 EMERGENCY SAFETY MEASURES**Water invasion**

Please cut off the AC power supply of the system first and then disconnect all switched under the premise of ensuring safety.

Electrolyte or gas leakage

If the battery pack leaks electrolyte, avoid contact with the leaking liquid or gas. If one is exposed to the leaked substance, immediately perform the actions described below.

- **Gas Inhalation:** Evacuate the people in the contaminated area and seek medical aid immediately.
- **Eye Contact:** Flush your eye with clean and flowing water for 15 min, and seek medical aid immediately.
- **Skin Contact:** Thoroughly rinse the exposed area with soap and water to be sure no chemical or soap is left on them, and seek medical aid immediately.
- **Ingestion:** Induce vomiting, and seek medical help immediately.

**WARNING**

Incase of fire situations, please use the extinguisher suitable for lithium- ion batteries, such as an extinguishing device containing the form of water dispersion of vermiculite.

2.2.3 OTHER TIPS

- All the product are strictly inspected before shipment, please contact your supplier for replacement if you notice there's any defectives such as swelling.
- Do not disassemble batteries and components, otherwise the manufacturer will not be responsible for any damage caused by unauthorized disassembly or repair.
- Do enable the battery to be safely grounded before use to make sure the system in safe and normal operation.
- Please ensure that the electric parameters of these devices are compatible mutually before connecting the battery to other devices.
- Please take the environmental factors into careful considerations to ensure that the system can work in a suitable condition as the environment and storage methods have a certain impact on the service life and reliability of this product.

3. PRODUCT OVERVIEW

3.1 INTRODUCTION

The KT-LFPES512100 battery is designed for residential application and works as a storage unit in the photovoltaic system. It is a 51.2V lithium battery system, with BMS inside. It could be operated in both on-grid, back-up and off-grid modes with compatible inverters. Below is the general schematic of an ac-coupled system with the batteries.

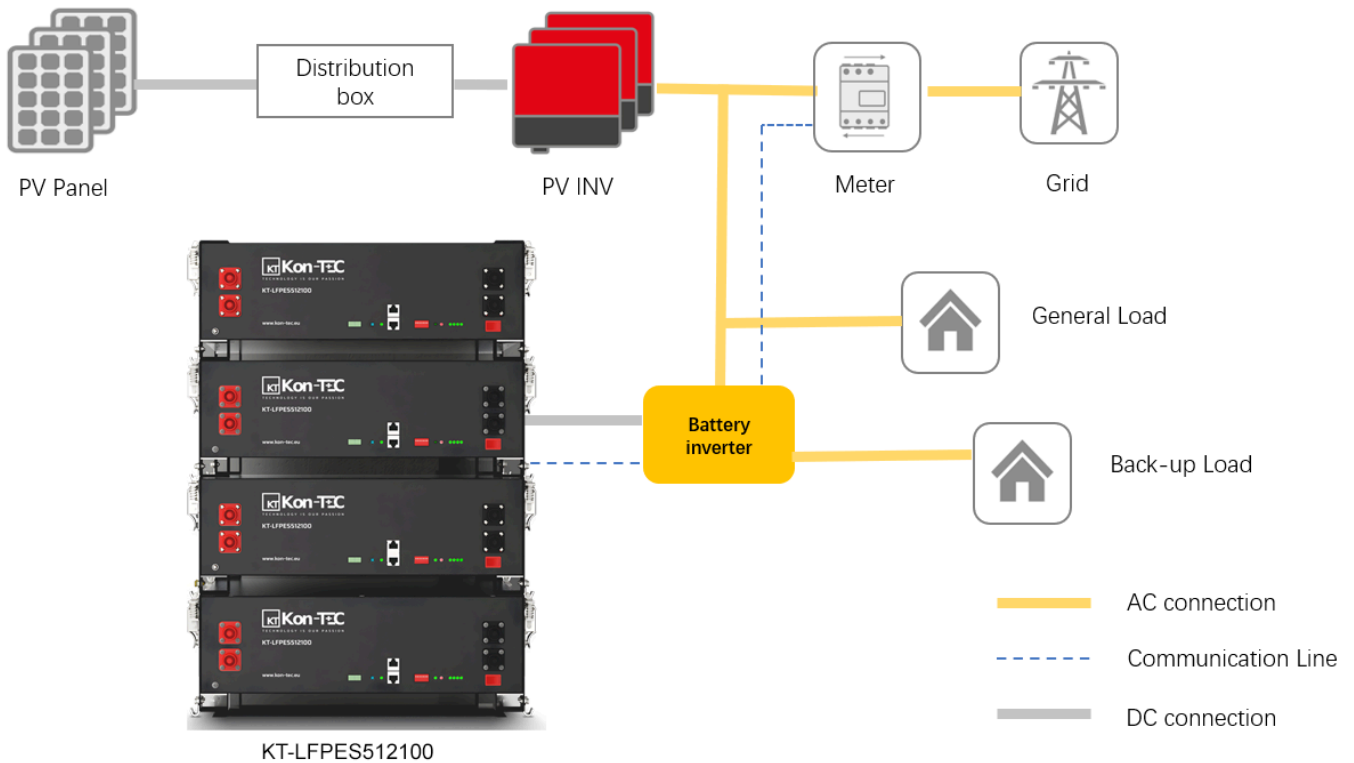

CAUTION

This electrical connection in this diagram is only for illustration, please follow the Manual suggestions of related devices and operate in accordance with locally applicable connection requirements, standards, and directives.

3.2 FEATURES

- Highest safety, battery is made from LiFePO4 chemistry and comply with highest international safety and transport standard.
- Modular and flexible, support up to 32 batteries connect together to expand the system energy.
- Built-in pre-charge circuit to avoid rush current when connecting with different inverter/chargers.
- Automatic dynamic addressing function when connected multiple batteries together.
- Support a maximum of 96% DOD under off-grid and back-up application
- Built in BMS provide warning and protection functions including over-discharged, over-charged, over-current, short-circuit and high/low temperature.
- LiFePO4 as cathode material and automatic balancing function to meet longer cycle life
- Compact size and light weight for easy installation and maintenance.
- Multiple installation bracket to adopt with different customers' requirement.
- LED display, CAN/RS485 port for external communication and upgrade the BMS firmware.

3.3. SPECIFICATION

3.3.1 DIMENSION

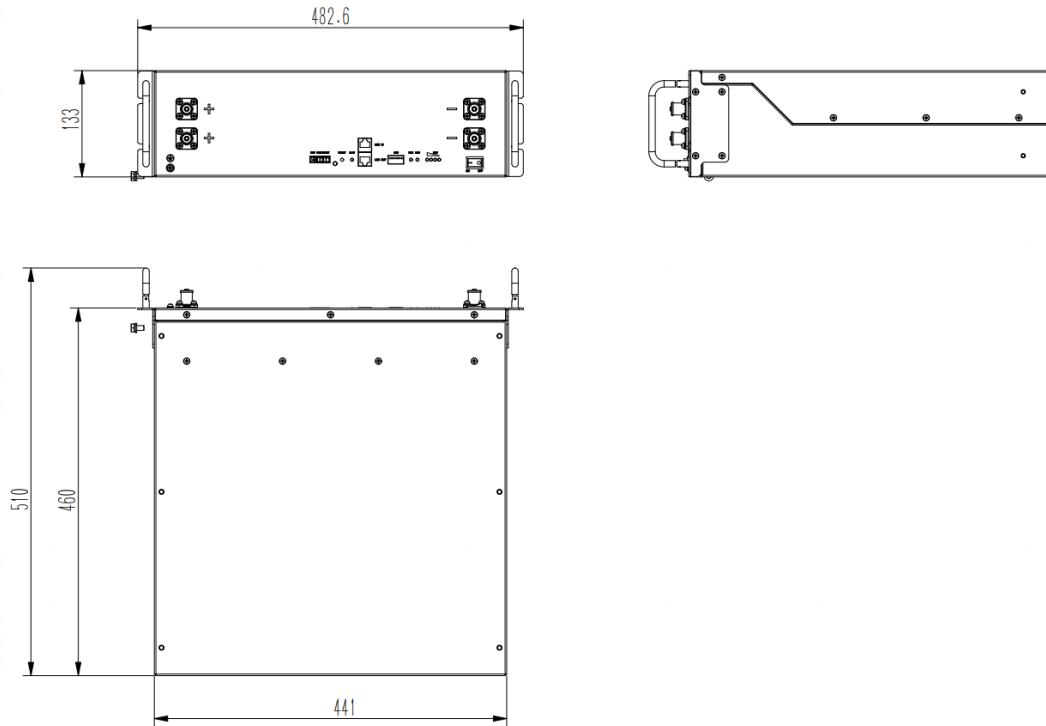

3.3.2 PARAMETERS

ITEMS	KT-LFPES512100	
Rated voltage	51.2V	
Max. voltage range	44.8~57.6V, Shipping voltage>51.2V	
Charge voltage	56.0V	
Float charge voltage	54.6V	
Nominal energy@0.2C	5.12KWh	
Usable energy@0.2C	4.92kWh	
Nominal capacity@0.2C	100Ah	
Dimension	482*133.5*460mm (18.9*5.2*18.1 inch)	
Weight	~46kg (101lb)	
Standard charge current	≤50A	
Max. charge current	70A	
Standard discharge current	≤50A	
Max. discharge current	90A (initial temp. ≤30°C)	
Communication	RS485 /CAN	
Max parallel number	32pcs	
Operation temperature 1	Charge: 5~50°C Discharge: 5~50°C	
Storage temperature @off mode	0°C<T<30°C	<6 months
	-10°C<T<45°C	<3 months
	Recommended environment	15~35°C, 5~75%RH

NOTICE

The optimum operating temperature range is from 15°C to 30°C, Frequent exposure to the harsh temperatures may worsen the performance of the battery pack and cycle life.

3.3.3 PANEL INTERFACE

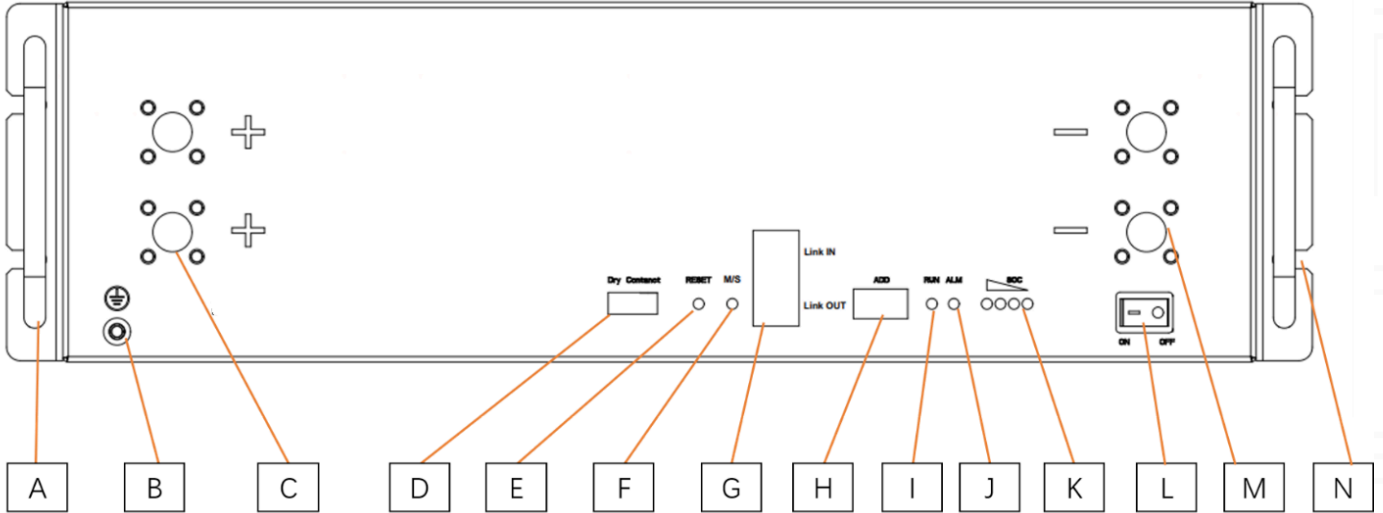

NO.	ITEMS	USAGE DESCRIPTION	REMARK
A	Handles	For handling, intallation and disassembly of battery	
B	Grounding	Used to connect battery with ground	
C	Positive terminal	Used to connect the inverter/charger	
D	Dry contact	1 channel input signal 2 channels output signal	
E	Reset	Used to sleep(3s)/awake(3s)/reset(6~10s) BMS in power on mode.	
F	M/S	Used to indicate the module is Master or Slave battery	Single mode:OFF Parallel mode: ON- Master battery OFF-Slave battery
G	Link IN Link OUT	For internal and external communication	
H	DIP	Used to set the RS485 baud rate and inverter protocol choosing	
I	RUN	Used to show battery is in running status when lighting or flashing	
J	ALM	Used to show battery Alarm/Protection status	
K	SOC	Used to show battery real-time SOC	
L	Power switch	Used to Power on/off battery	
M	Negative terminal	Used to connect the inverter/charger	
N	Mounting ear	Used to fix with rack or cabinet	

3.3.3.1 D: DRY CONTACT

PIN	Type
1	NO Output1, Charge enable/disable signal
2	
3	NO Output2, discharge enable/disable signal
4	
5	Passive INPUT signal.
6	Rapid Shut Down function for US

3.3.3.2 G: LINK IN / LINK OUT

PORT	PIN NO.	DEFINITION	REMARKS
Link IN	1	RS485-B1	1.Used to connect with external devices to establish communication. 2.Used to connect with upper battery pack Link OUT.
	2	RS485-A1	
	3	SGND	
	4	CAN-H	
	5	CAN-L	
	6	SGND	
	7	RS485-A1	
	8	RS485-B1	
Link OUT	1	RS485-B2	Used to connect with downward battery pack Link IN.
	2	RS485-A2	
	3	SGND	
	4	CAN-H	
	5	CAN-L	
	6	SGND	
	7	RS485-A2	
	8	RS485-B2	

3.3.3.3: DIP ADDRESSING

DIP	REMARKS						
	RS485 BAUD RATE				UNDEFINED		PROTOCOL
1	2	3	4	5	6	7	
ON: 115200	Reserved for multiple cluster parallel and other future function				0	0	Protocol ID0
OFF: 9600					1	0	Protocol ID1
					0	1	Protocol ID2
					1	1	reserved
Keep all batteries the same setting	Keep default setting				Master: according to inverter brand Slave: keep default setting		

PROTOCOL ID	CANBUS CONNECTION	RS485 CONNECTION	DIP SETTING (MASTER BATTERY)
0	Victron/SMA/Studer Innotec/Sofar	Voltronic/RCT/MPP/Alpha outback/Phocos	 X000000
1	Sol-Ark/Solis/Goodwe/Deye/ Growatt/SAJ/LUXPOWER Megarevo/INVT/Sermatec/ TBB/MUST/Sunsynk		 X000010

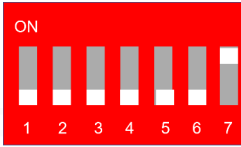
PROTOCOL ID	CANBUS CONNECTION	RS485 CONNECTION	DIP SETTING (MASTER BATTERY)
2	Schneider		 X000001

NOTICE
 Fail to follow the DIP switch setting will cause the communication fault between battery and inverter, for more detail setting with different inverter/charger, please contact your supplier for consultation.

3.3.3.4 RUN/ALM/SOC

MODE	STATUS	RUN	ALM	LED INDICATOR				DESCRIPTION
		●	●	●	●	●	●	
Power off	-	OFF	OFF	OFF	OFF	OFF	OFF	All OFF
Standby	Normal	FLASH1	OFF	According to battery SOC				See note
	Warning	FLASH1	FLASH3					
Charge	Normal	ON	OFF	According to battery SOC (highest SOC LED: FLASH2)				See note
	Warning	ON	FLASH3					
	COCP	FLASH1	OFF	According to battery SOC				Stop charging
Discharge	Normal	FLASH3	OFF	According to battery SOC				See note
	Warning	FLASH3	FLASH3					
	CUVP/PUVP	OFF	FLASH3	OFF	OFF	OFF	OFF	Stop discharging
	DOCP	OFF	ON	OFF	OFF	OFF	OFF	Stop discharging
Temperature	CHTP/DHTP CLTP/DLTP	OFF	ON	OFF	OFF	OFF	OFF	Stop charging/discharging
Failure	Cell/NTC failure Sensor failure MOS failure Reversed polarity /SCP	OFF	ON	OFF	OFF	OFF	OFF	Stop charging/discharging

Note: 'Warning' including items of cell imbalanced/low voltage/high current/high&low temperature.

FLASH TYPE	ON	OFF
FLASH1	0.25S	3.75S
FLASH2	0.5S	0.5S
FLASH3	0.5S	1.5S

3.4 PROTECTION FUNCTION

ITEMS	DESCRIPTION	REMARK
Charge end COVP POVP	The BMS will stop charging if any cell or PACK voltage reach the protection value and it will be auto-released only when both Pack and cell voltage back to the release voltage range or there is efficient discharge current.	
Discharge end CUVP PUVP	The BMS will stop discharging if any cell or PACK voltage is under the protection value and it will be released only when all the cell voltage back to the release voltage range or there is efficient charge current.	Can Automatic recovery. Please charge timely, otherwise it may be in Low-power mode to be over-discharged and damage battery.

ITEMS	DESCRIPTION	REMARK
CHTP DHTP	The BMS will stop charging or discharging or both if any cell/ environment/MOS temperature is beyond the range.	Automatic recovery when temperature falls.
CLTP DLTP	The BMS will stop charging or discharging or both if any cell/ environment/MOS temperature is under the range.	Automatic recovery when temperature rise.
COCP	The BMS will stop charging when the charging current is higher than the protection value. And it will release from the protection when the system delays time is met.	Automatic recovery. If locked after three consecutive times, manual intervention is required.
DOCP	The BMS will stop discharging when the discharging current is higher than the protection value. And it will release from the protection when the system delays time is met	Automatic recovery. If locked after three consecutive times, manual intervention is required.
SCP Reversed polarity	The BMS will stop charging when detect short circuit or reversed polarity.	Charge to release. Manual press reset.
Temperature, Voltage, Current sensor failure	Enter the failure mode, manual intervention is required no charging and discharging.	Manual intervention.
Sleep mode	After reaching a certain condition, BMS will enter dormancy mode to reduce BMS consumption	Charge, press reset or restart to activate.



CAUTION

Please re-charge the battery via MPPT, grid/generator or other energy source within 24h if the battery is over discharged, otherwise, it may be damaged.



NOTICE

Manually short-circuit and reverse the battery will void the warranty.

4. INSTALLATION

4.1 PREPARATION

4.1.1 SAFETY COMPLIANCE

The system installation must be finished by qualified person(s). During the whole installation process, please strictly follow the local safety regulations and related operating procedures.









4.1.2 ENVIRONMENT

The operating environment shall meet the following requirements:

CATEGORY	DESCRIPTION
Working temperature	5°C-50°C(maximum operating range) 15°C-30°C (optimal temperature)
Relative humidity	5%~90%, No condensation
Altitude	<3000m
Safety requirement	Do not expose the battery to direct sunlight, rain and snow. Do not place the battery within children/pet touchable area. Do not place the battery near heat source and flammable material Do not drop, deform, impact, cut or spearing with a sharp object. Do not put heavy things on battery. Do not disassemble the battery without Manufacturer's permission. No conductive dust and water or other liquid to contact battery. Follow the emergency measure if there is water invasion or electrolyte and gas leakage. Contact your supplier within 24 hours if any product failure happens.

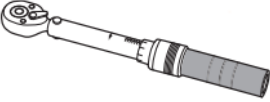
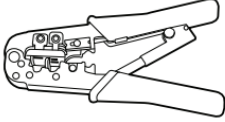
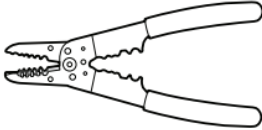
4.1.3 TOOLS

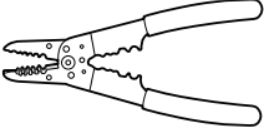
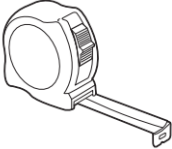
TOOLS

			
Torque screwdriver	Multi-meter	Flat-head screwdriver	Phillips-head screwdriver
			
Torque wrench	Cable crimper	Wire stripper	Drill
			
Wire stripper	Tape measure	Phillips-screwdriver bit	Hex-key bit

4.2 INSPECTION

4.2.1 UNPACKING

- Please load and unload it in accordance with the specified requirements to prevent sun and rain when you receive the equipment.
- Please check and confirm the goods (such as quantity, appearance, etc.) according to the „scope of delivery „ before unpacking.
- Do light take and put during unpacking process to protect the surface coating of the object;
- Please record and feedback to the manufacturer if the inner packing is damaged after unpacking.

4.2.2 SCOPE OF DELIVERY

Check the scope of delivery for completeness and any externally visible damage. Contact your supplier for supplementary delivery if the listed material is incomplete or damaged.

GENERAL MATERIALS (BATTERY UNIT)

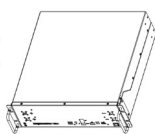

Battery Pack *1pcs



Manual *1pcs

Warranty document *1pcs

OPTIONAL MATERIALS (NOTED THAT EACH PACK UNIT TOGETHER WITH ONE TYPE BRACKET AS DEFAULT)

MOUNTED KITS TYPE	MATERIAL DETAIL	QTY.
Rack mounted kits (Packing with general materials, with mark on the carton)	A: Float nuts M6 	6pcs
	B: Combination Screw	4pcs

**OPTIONAL MATERIALS
(NOTED THAT EACH PACK UNIT TOGETHER WITH ONE TYPE BRACKET AS DEFAULT)**

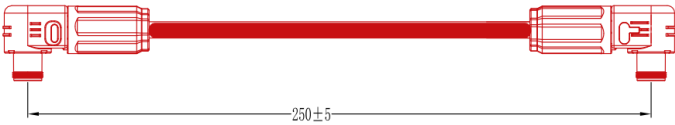
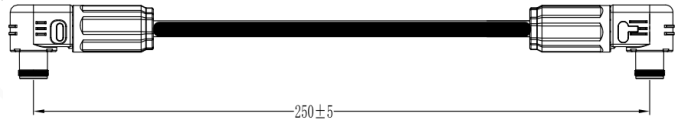
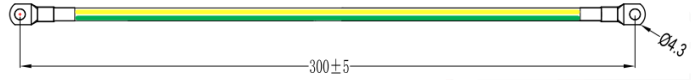
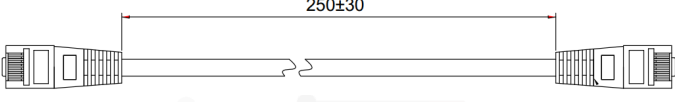
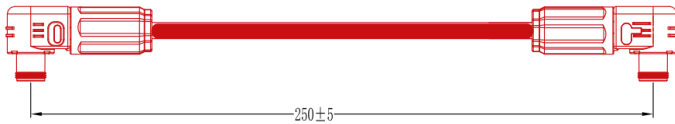
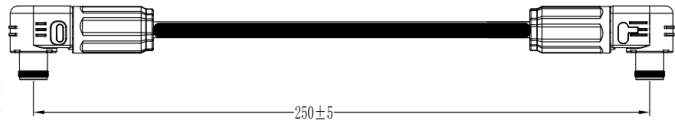
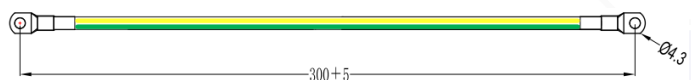
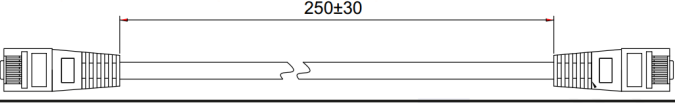
MOUNTED KITS TYPE	MATERIAL DETAIL	QTY.
	<p>C: Battery to battery parallel positive cable(250mm)</p> 	1pcs
	<p>D: Battery to battery parallel negative cable(250mm)</p> 	1pcs
	<p>E: Battery to battery grounding cable(300mm)</p> 	1pcs
	<p>F: Battery to battery communication cable(250mm)</p> 	1pcs
Stack mounted kits (Packing using separately carton)	A: Stacking components	4pcs
	B: Head screw M4	16pcs
	<p>C: Battery to battery parallel positive cable(250mm)</p> 	1pcs
	<p>D: Battery to battery parallel negative cable(250mm)</p> 	1pcs
	<p>E: Battery to battery grounding cable(300mm)</p> 	1pcs
	<p>F: Battery to battery communication cable(250mm)</p> 	1pcs
Wall mounted kits (Packing using separately carton)	A: External hexagon slotted combination screw	6pcs
	B: Cross recessed recessed combination screw	2pcs

**OPTIONAL MATERIALS
(NOTED THAT EACH PACK UNIT TOGETHER WITH ONE TYPE BRACKET AS DEFAULT)**

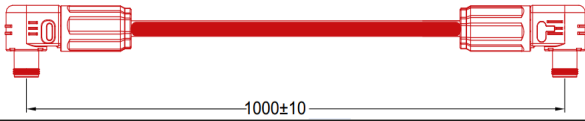
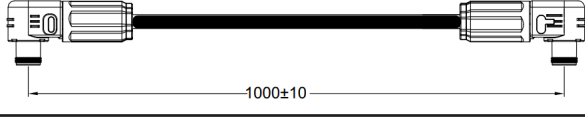
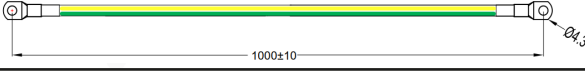
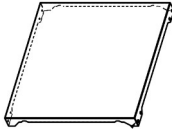
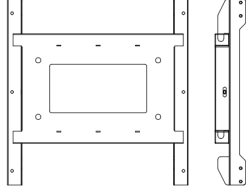
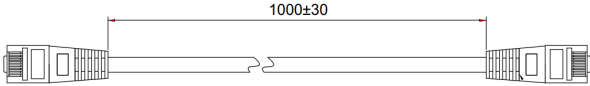
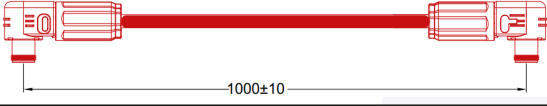
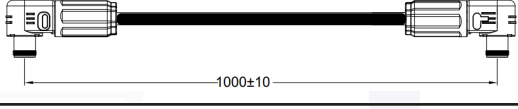
MOUNTED KITS TYPE	MATERIAL DETAIL	QTY.
	C: Battery to battery parallel positive cable 	1pcs
	D: Battery to battery parallel negative cable 	1pcs
	E: Battery to battery grounding cable 	1pcs
	F: Cross recessed small countersunk head screws	16pcs
	G: Expansion bolt M10*60	4pcs
	H: Decorative panel 	1pcs
	I: Wall mounted bracket 	1pcs
	J: Battery to battery communication cable 	1pcs
Floor mounted kits (Packing using separately carton)	A: Outer hexagon combination bolt	4pcs
	B: Cross recessed small countersunk head screws	12pcs
	C: Battery to battery parallel positive cable 	1pcs
	D: Battery to battery parallel negative cable 	1pcs
	E: Battery to battery grounding cable	1pcs
	F: Battery to battery communication cable	1pcs
	G: Base	1pcs
	H: Decorative panel	1pcs
	I: Side fixing parts	2pcs
	J: Expansion bolt M6*50	6pcs

**OPTIONAL MATERIALS
(NOTED THAT EACH PACK UNIT TOGETHER WITH ONE TYPE BRACKET AS DEFAULT)**

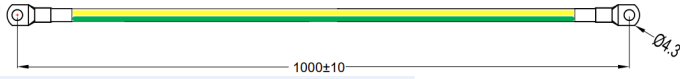
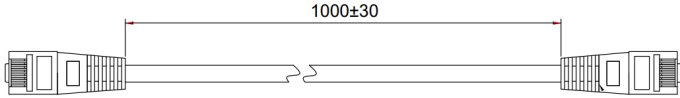
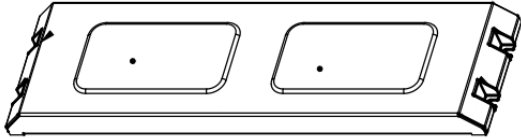
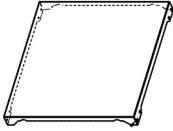
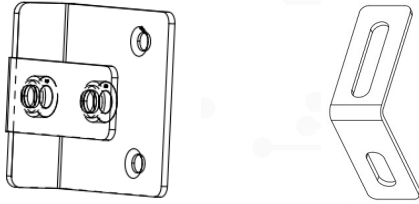
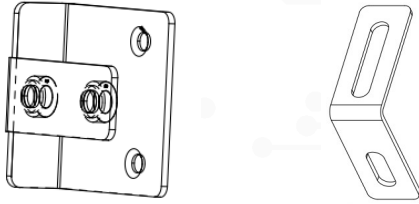
MOUNTED KITS TYPE	MATERIAL DETAIL	QTY.
	E: Battery to battery grounding cable 	1pcs
	F: Battery to battery communication cable 	1pcs
	G: Base 	1pcs
	H: Decorative panel 	1pcs
	I: Side fixing parts 	2pcs
	J: Expansion bolt M6*50 	6pcs

4.2.3 EXTERNAL CABLE KITS

Cables connected to inverter or junction box belongs to an External Cable kits, NOT include in battery carton. Customers need buy it separately, the information are as below.

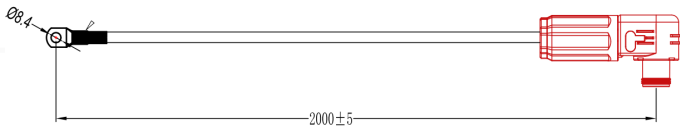
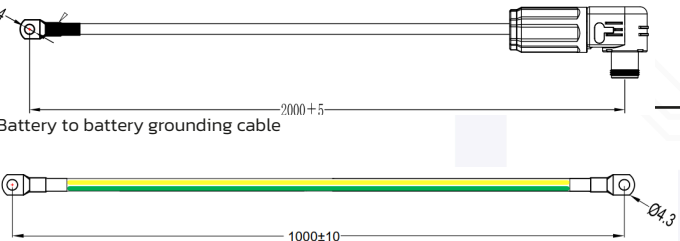
MOUNTED KITS TYPE	MATERIAL DETAIL	QTY.
Power cable		1pcs
Grounding cable	E: Battery to battery grounding cable 	1pcs

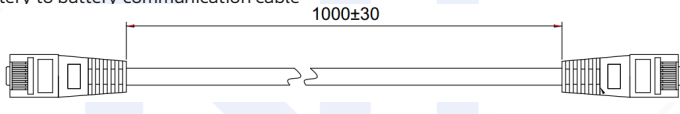
MOUNTED KITS TYPE	MATERIAL DETAIL	QTY.	
Inverter communication cable (1 out of 3)	J: Battery to battery communication cable 	1pcs	
		Battery side pin	Inverter side pin
	Version I(CAN):	Pin 4	Pin 7
		Pin 5	Pin 8
		Pin 6	Pin 3
	Version II(CAN):	Pin 4	Pin 4
		Pin 5	Pin 5
	Version III(RS485):	Pin 1	Pin 3
	Pin 2	Pin 5	

For inverter communication PIN definition detail, please check Appendix I

NOTICE
Keep the unused cable pins NULL to avoid affecting the closed loop communication.

NOTICE
A ground connection of communication cable may be required from some inverters, please follow the rules from inverter manufacture.

4.3 START INSTALLATION

Qualified person

4.3.1 REMAINDER

Please check again the following conditions or equipment whether meet the requirements before installation:

- Check if there's enough space for installation, and if the load-bearing capacity of the bracket or cabinet meets the weight requirements.
- Check whether the power cable pair(s) used meets the maximum current requirement for operation.
- Check whether the overall layout of power supply equipment and batteries at the construction site is reasonable.
- Check whether the installer is wearing anti-static wristband.
- Check whether there're two people on the construction site for installation work.
- Check if there's potential risks at location of installation site, e.g flooding, sun exposure, corrosion, and salt spray.

4.3.2 PROCEDURES

CAUTION
Injuries may result if the product is lifted incorrectly or dropped while being transported or mounted. Wear suitable personal protective equipment for all work on the product.

CAUTION
Ensure that no lines are laid in the wall which could be damaged when drilling holes.

4.3.2.1 RACK MOUNTED

- I. Take the battery pack out from carton.
- II. Get the Rack or cabinet ready and place it horizontally at a reasonable location.
- III. Place the battery on the rack or cabinet tray via manual-lift, Insert the screws and fasten the battery to the rack or cabinet.
- IV. Finish the cable connection

4.3.2.2 STACK MOUNTED

I. Take the battery pack out from carton.

II. Remove the mounting ear from both side of the battery.

III. Install the stacking component at four corners of the battery.

IV. Remove the hook on the stacking component of the bottom battery of each stack.

V. Put another battery on top of the previous module, and align the locating holes and connect the 4 lockers together.

VI. The maximum number in each stack is 4 modules.
VII. Finish the cable connection



Note: Do not stack the batteries directly.

4.3.2.3 WALL MOUNTED

I. Take the battery pack out from carton.

II. Remove the mounting ear from both side of the battery, and separate the wall mounting bracket and widget.

III. Take out the wall mounting bracket, place it onto the wall horizontally and mark the hole position on the panel.

IV. Drill holes in the wall for the M10 expansion bolt. The drilling depth should be at least 60 mm, insert the bolt.

V. Fix the bracket with the nut

VI. Fix the wall mounting widget and the decorative panel with the battery using the combination screw

VII. Lift the battery up and put the hook into the bracket hanging hole, fix the widget with the bracket via the combination screw and tighten it using a screwdriver

VIII. Finish the cable connection

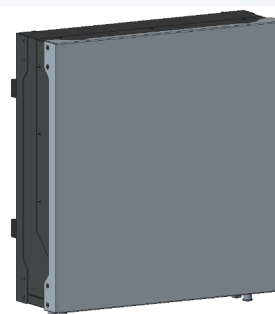
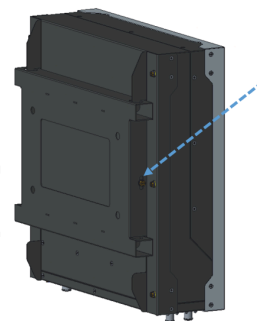
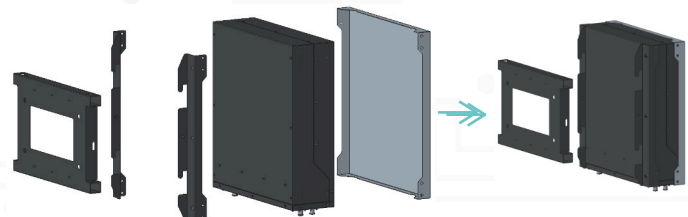
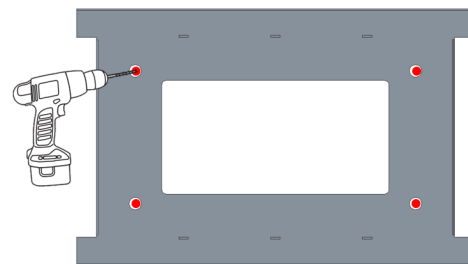

4.3.2.4 FLOOR MOUNTED

I. Take the battery pack out from carton.

II. Remove the mounting ear from both side of the battery, and separate the wall mounting bracket and widget.



III. Place the base near the wall, align with the wall and make sure the distance is between 10mm and 35mm.

IV. Drill holes on the ground for the M6 expansion bolt. The drilling depth should be at least 50 mm, insert the bolt. (this step is optional)

V. Fix the base with nut. (this step is optional)

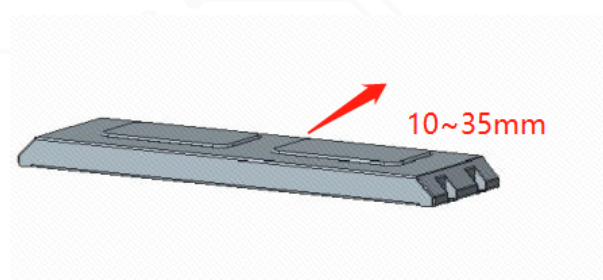

VI. Fix the decorative panel and wall hang ear with the battery using the combination screw, and place the battery onto the base.

VII. Adjust the position of the hang ear, make sure they can connect wall smoothly, mark the hole position of both hang ear.

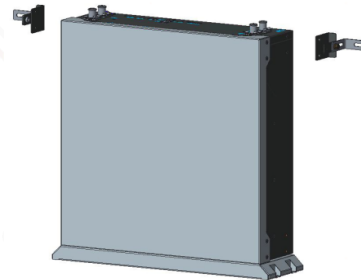

VIII. Remove hang ear from the battery, and drill holes in the wall for the M6 expansion bolt. The drilling depth should be at least 50 mm, insert the bolt.

IX. Fix the hang ear with battery and fasten the bolt with nut.

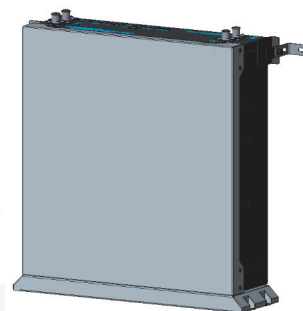

Finish the cable connection

4.3.3 TIPS

4.3.3.1 INSTALLATION NOT ALLOWED

Direct upside down

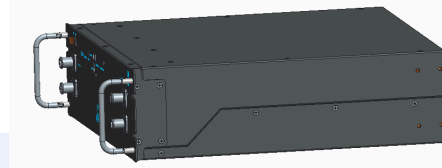

Left side flip

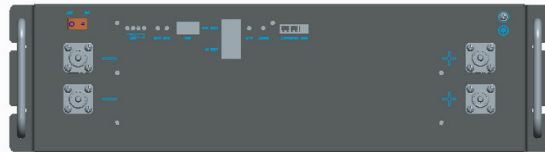

Right side flip



4.3.3.2 OTHER INSTALLATION

Placing on the desk

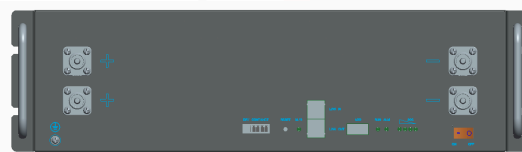

Please make sure the desk can bear the total weight.

Hang on the wall with Holder



Please make sure the holder can handle a minimum weight of 50kg



NOTICE

ANYothers installations, please avoid the battery directly contacting the ground and avoid of high salinity, humidity to prevent the product from rusting and corrosion.

5. CABLE CONNECTION AND COMMISSIONING

⚠ Qualified person

5.1 GET BATTERY READY

5.1.1 Ensure all the battery is in OFF mode, check and confirm the installation is tighten and stable.

5.1.2 Check the number and specification of cable kit accessories are correct according to the Scope of delivery item, if you are making cable yourself, please follow manufacturer's requirements.

5.1.3 Switch on all battery individually before wiring, check whether there is any alarm/protection information, if yes, turns to troubleshooting. Then switch off all batteries.

5.2 GROUNDING CABLE CONNECTION

5.2.1 Take out the grounding screw on the battery panel, and get the cable conductor through it.

5.2.2 Fix them together, with a cylinder screwdriver and tighten it.

5.2.3 Connect the grounding cable with next battery module.

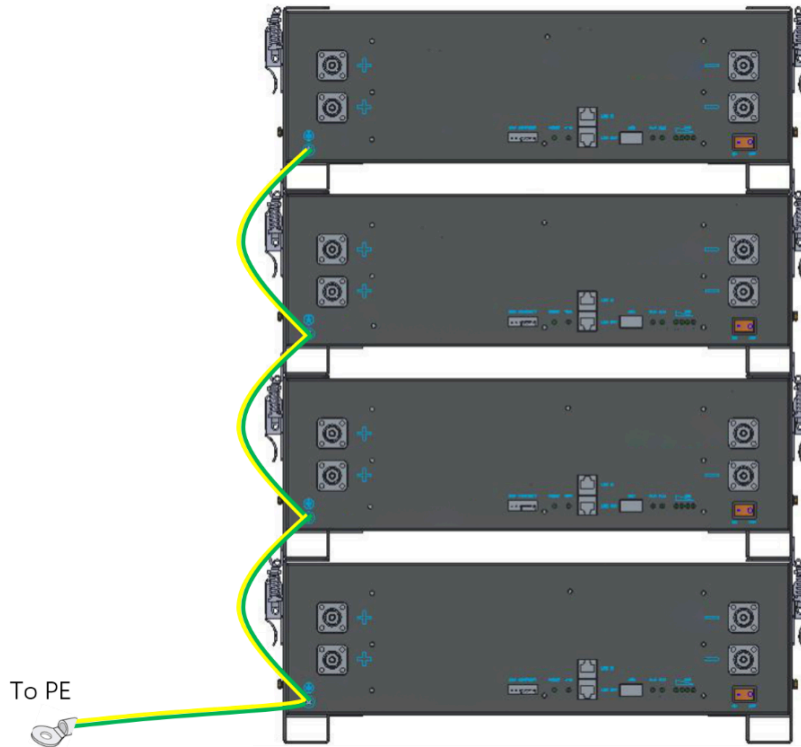

5.3 COMMUNICATION CABLE CONNECTION

5.3.1 Take out battery to battery communication cable.

5.3.2 Confirm the location of Master battery, insert the RJ45 plug into the Link Out port and connect the other side to next battery Link IN port, daisy chained all batteries.

Note: the module with empty Link IN port is Master battery



NOTICE

TheBMS inside the battery pack will automatically terminate BOTH end of CANBUS pins, DO NOT need to plug the 120Ω terminator again.

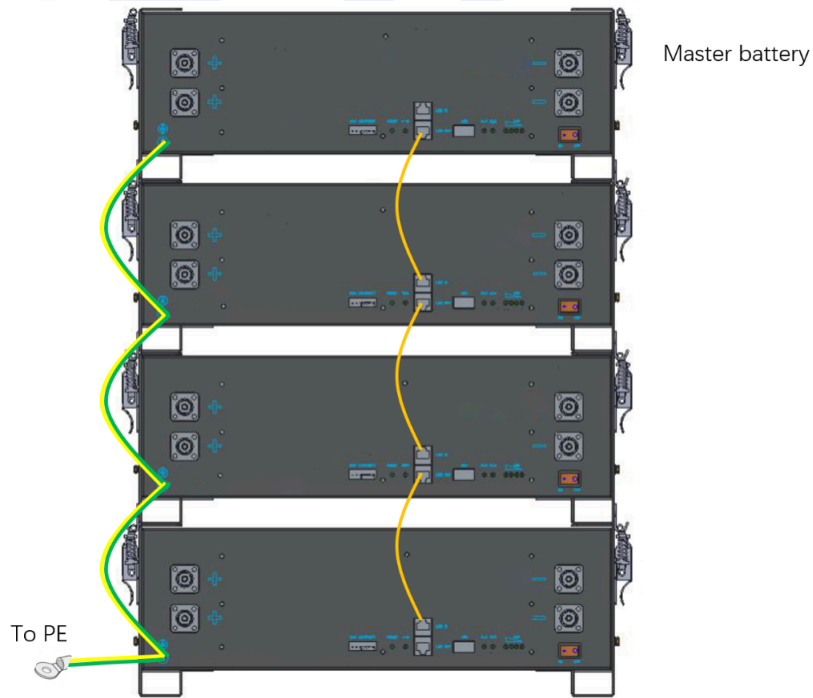

5.4 ILLUSTRATIVE DC POWER CABLE CONNECTION (EXAMPLE ONLY FOR MAX. 100A, 5KW RATING)

- 5.4.1 Take out battery to battery power parallel cable.
- 5.4.2 Insert the Plug into the power socket until you hear the 'click' sound.

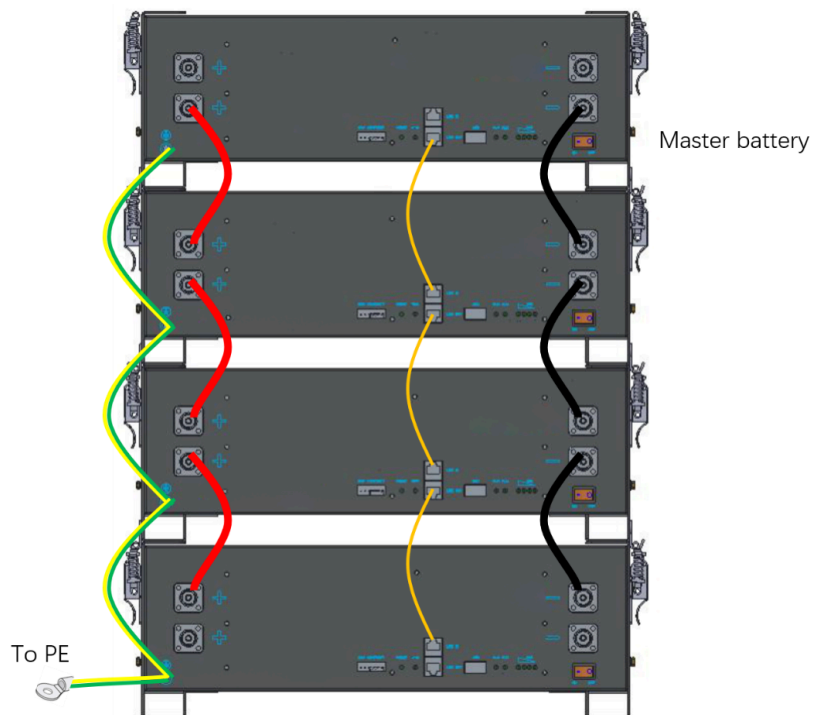

5.5 CONNECTING WITH INVERTER

**CAUTION**

Confirm inverter AC input and PV input is disconnected before wiring connection, and the DC/ signal switch of inverter/charger is in off status.

5.5.1 Connecting Master battery Link IN port with inverter CAN or RS485 communication port via inverter communication cable (Version I/II/III or customized).

5.5.2 Connecting battery OUTPUT (+) with inverter battery INPUT (+), battery OUTPUT (-) with inverter battery INPUT (-), an external disconnection breaker between battery system and inverter is recommended, choose the corresponding power cable pair and wiring them correctly.

Note:

**NOTICE**

Choose the suitable disconnection breaker considering the inverter power/current, rated voltage, tripping characteristic etc.

**DANGER**

Depending on the output power of the energy storage, the cross-sections of wires should be properly matched and the appropriate connection diagram (type) should be used.

ALLOWED CONNECTION DIAGRAMS (TYPES)

Type 1: Maximum continuous current 100A, maximum energy storage output power 5kW.

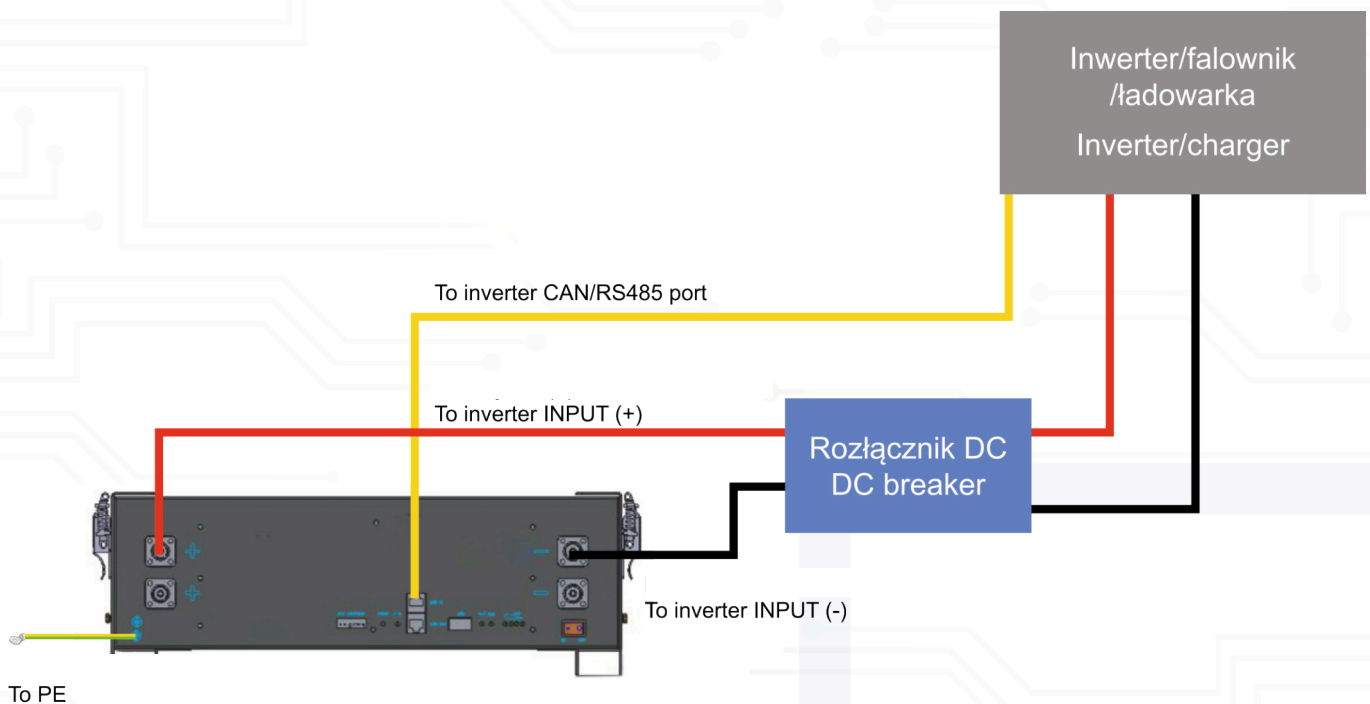

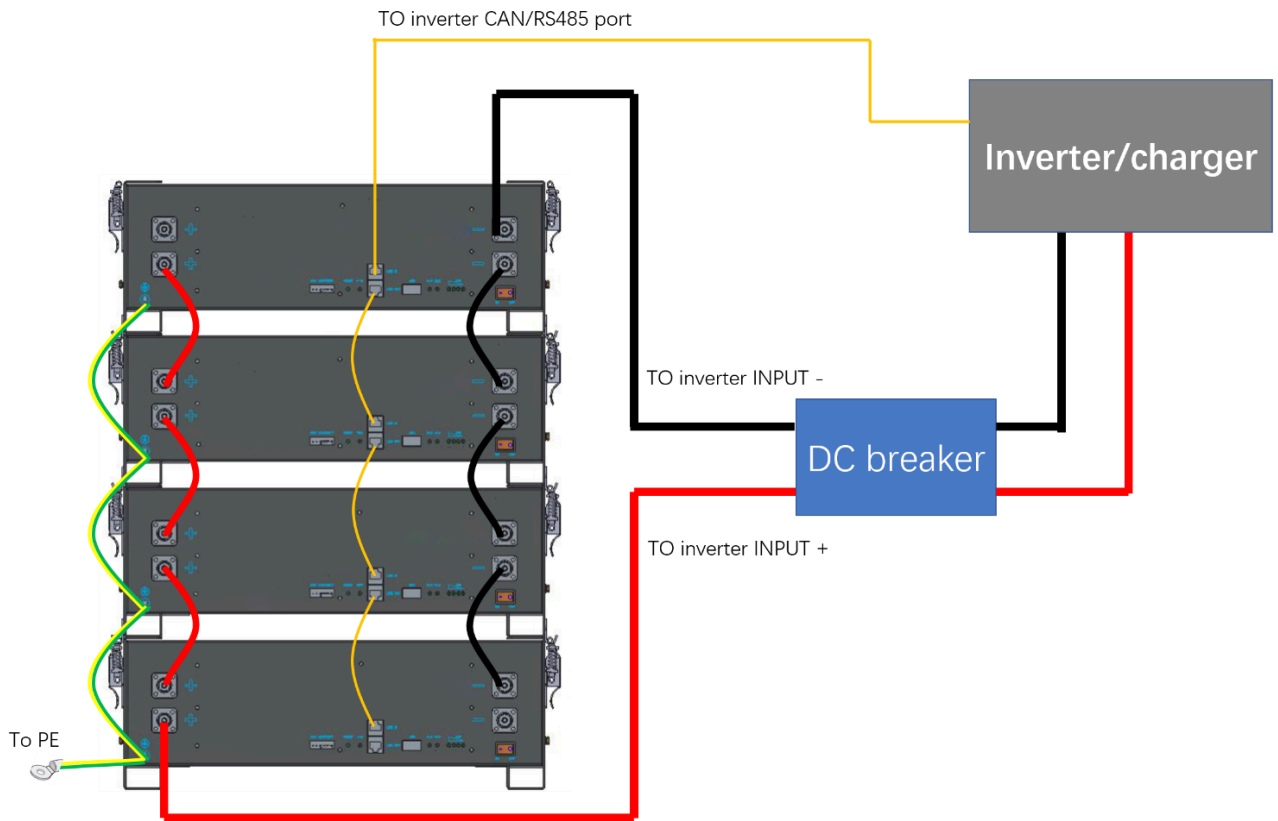
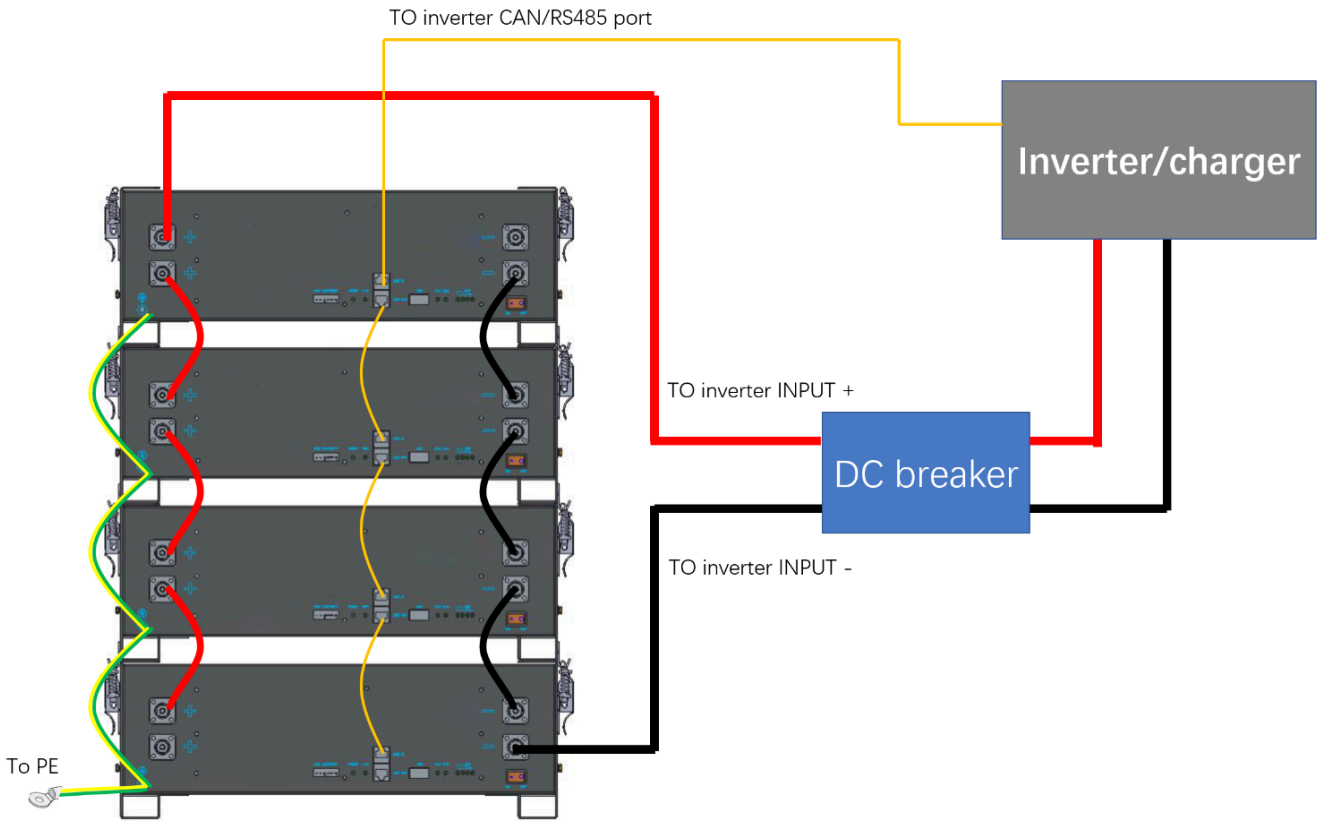

Type 2: Maximum continuous current 200A, maximum energy storage output power 10kW.

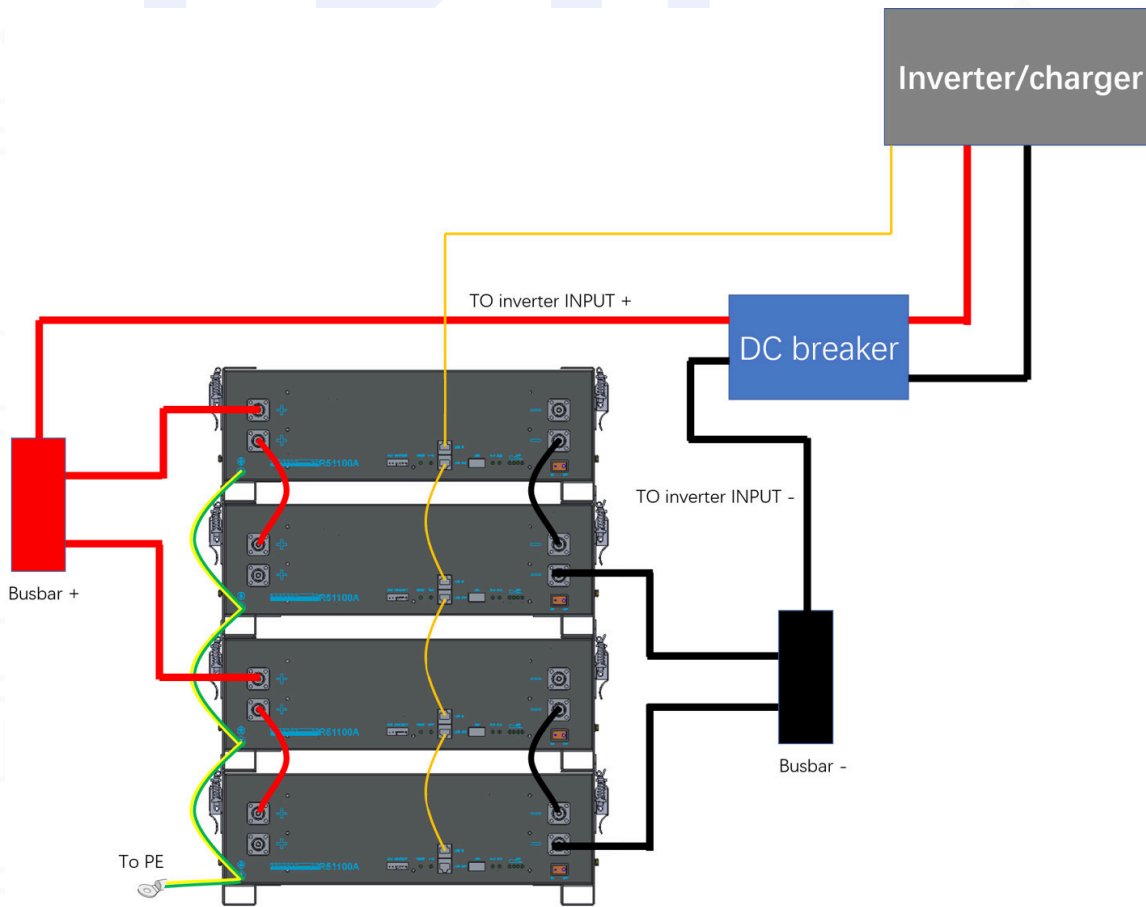

Type 3: Maximum continuous current 400A, maximum energy storage output power 20kW.

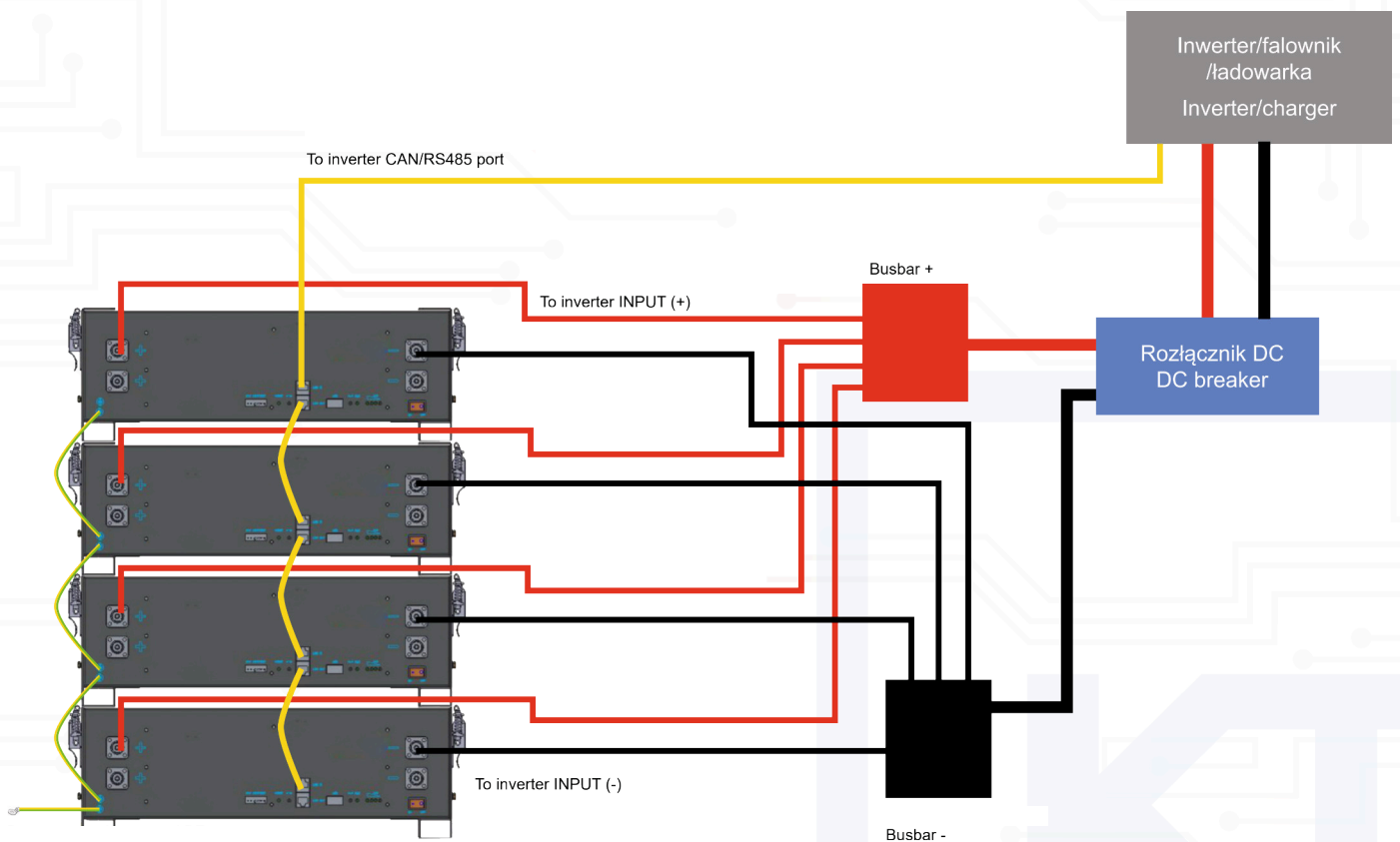

WIRING DIAGRAM NOT ALLOWED:

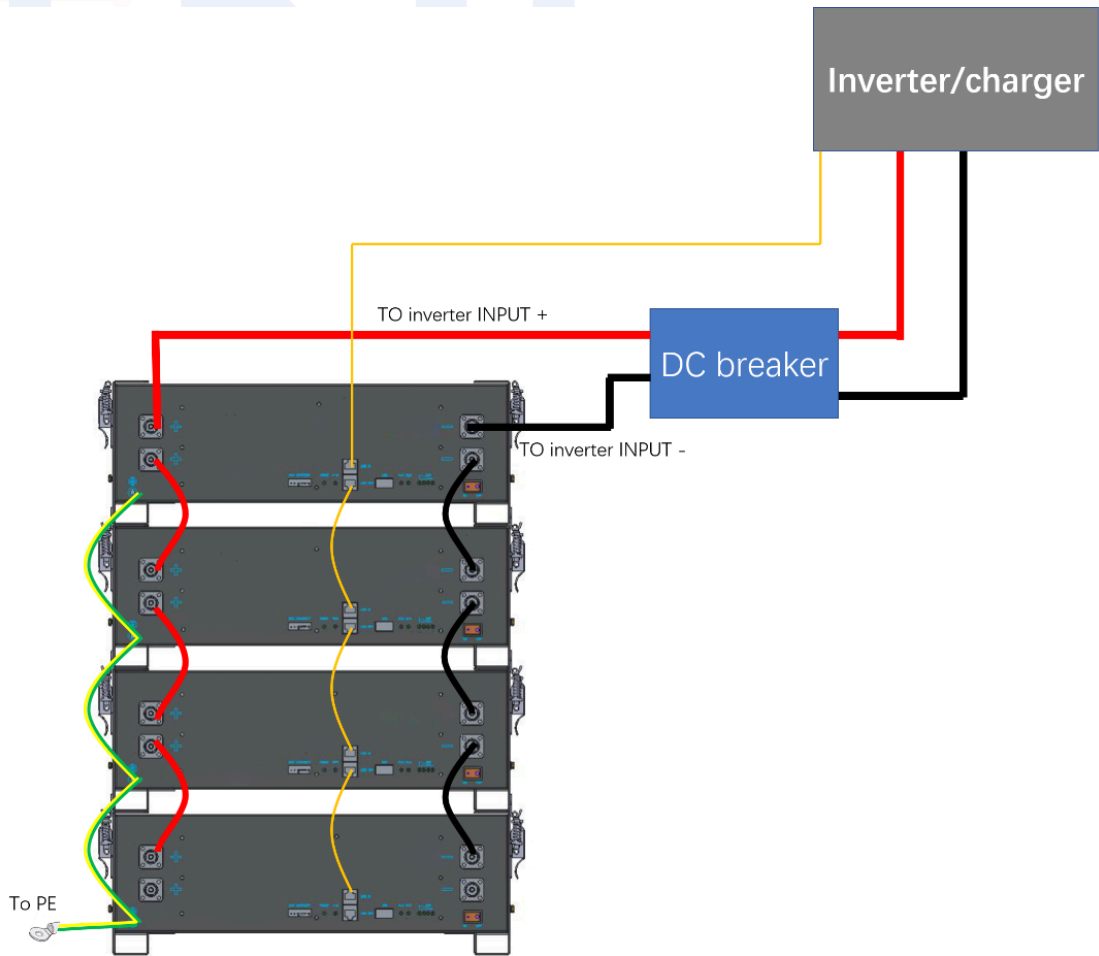

NOTICE

The maximum communication cable length is required to be less than 15m between inverter/charge and battery.
The maximum power cable length is suggested to be less than 10m between inverter/charge and battery.
For Australia market please contact with Kon-TEC.



CAUTION

The maximum tolerance current of each power cable and terminal is 125A, 100A for continuously is suggested, please use corresponding number of power cable pairs according to the field configuration and local connection requirements, standards, and directives.

5.6 COMMISSIONING

- 5.6.1 Set the DIP address of the Master battery (and the Slave battery if there is any RS485 baud rate changed).
- 5.6.2 Switch on all battery modules, wait for 10s, make sure that only M/S led is on Master battery.
- 5.6.3 Turn on the breaker between the inverter and battery if there is any, then turn on the inverter/charger isolator.
- 5.6.4 Finish the setting on inverter/charger or any other control devices, if everything is correct, you are ready to use the system.

NO.	INVERTER SETTING PARAMETERS	DETAIL
1	Absorption voltage	56.0V
2	Float voltage	54.6V
3	Re-charge/Generator start voltage	≥50V
4	Re-start voltage	52V
5	Low SOC limit (Grid-tied)	10/20% (differ from inverter brand)
6	Low SOC cut-off	4.00%
7	Low Voltage cut-off	48.0V
8	Rated charging current limited value	50A*N (N is the Quantity of the battery pack)
9	Rated discharging current limited value	50A*N (N is the Quantity of the battery pack)
10	Max. charging current limited value	70A*N (N is the Quantity of the battery pack)
11	Max. discharging current limited value	100A*N (N is the Quantity of the battery pack)
12	Force charge	Enable

For more information to connect with different inverter/charger, please contact your supplier for technical support.



CAUTION

If your system is a back-up or off-grid system, make sure your configuration can cover the worst situation to avoid battery to be over-discharged.

5.7 SWITCH OFF BATTERY

- 5.7.1 Turn off the inverter.
- 5.7.2 Turn off the disconnection breaker if there is any.
- 5.7.3 Turn off all batteries signal switch.

6. TROUBLESHOOTING AND FAQ

ITEMS	SOLUTION	MEASURE
Unable to start	Power on battery and press RESET 6s to observe whether the battery can be started. Charge the battery use a charger or inverter to provide 54~57.6V voltage and observe it can be started.	<p>If the abnormal status still alive after above steps, please contact your supplier.</p> <p>If there is any other situation(s) excluding in this table, turn off the fault battery, contact your supplier.</p>
Unable to charge	Check whether the cable connection between the battery and the inverter/charger is correct. Check whether the inverter/charger setting is correct. Check whether the battery is in charge protection mode, if yes, try to discharge the battery.	
Unable to discharge	Check whether the cable connection between the battery and the inverter/charger is correct Check whether the battery occurs short circuit, reverse connection, pre-charge failure during connection inverter etc. Check whether the battery is in discharge protection mode, if yes, try to charge the battery.	
High/Low temperature	Stop the battery system for a while, check whether the installation location temperature meet the requirement. Avoid continuous full charging and discharging.	
High current	Check the configuration and parameters setting on the inverter/charger is correct.	
ALM always on	Turn off all the batteries, and remove the fault battery from the system, ask your supplier	
Communication fail	Check the communication cable type is correct and is contacted well. Check the DIP switch setting is correct. Check the inverter protocol related setting is correct. Check both battery and inverter are working properly.	

Q1: Battery maximum SOC is 99% and never goes to 100%SOC during daily cycle use, why?

Generally, there is no effect to system on this point. BMS will calibrate the SOC to 100% when reached cut-off current or trigger CHVP, however, to avoid battery from being overcharged and to extend the cycle life as longer as possible, we left a room and set a charging profile to let battery not be charged at high voltage near full. Keep float the battery for approximately 0.5~1 hour to calibrate.

Q2: 'High voltage' and 'cell unbalance' warning and alarm in rare cases, does it mean battery is damaged?

No. This is not unusual and happened on new batteries that are not balanced yet, please lower the maximum charge voltage (54.6V) and float the battery via grid or generator. If not solved, please contact your supplier.

Q3: When having multiple batteries in parallel connection, the battery on the end can't be fully charged.

Pay attention to your wiring diagram, please always follow the manual wiring advises and choose proper cable size and pair.

Q4: The current is 0A when connecting with a very small load at the situation that having multiple batteries in parallel connection, how to solve it?

Each BMS has a threshold current of 0.5A (~25W) before it begins to report, this leads the inaccurate display of the current.

Q5: SOC suddenly jump to 100% during charging.

This is normal in off-grid application and usually happened on batteries that not been calibrated SOC for long time, we suggest to fully charge the batteries per month.

7. TRANSPORT, STORAGE

- Do not violently shake, impact or squeeze, and prevent sun and rain during the transportation.
- Do light take and put and strictly prevent falling, rolling, and heavy pressure during loading and unloading.
- The battery should be placed in a dry, clean, dark, and well-ventilated indoor environment for long-term storage, and the recommended storage temperature range is 15~30°C.
- No harmful gases, flammable and explosive products and corrosive chemical substances in the storage location.
- The batteries should be stored and transported in close to 50% SOC, do not store over 80%SOC for long time.
- If do not use for a long time, the battery needs to be charged every 6 months.
- No fall down, no pile up over 6 layers, and keep face up.

8. DISPOSAL OF BATTERY

Disposal of battery must comply with the local applicable disposal regulations for electronic waste and used batteries, please review your local Battery recycling or management regulations or contact your supplier for more information.

9. APPENDIX - INVERTERS / CHARGERS CONNECTIONS

Connect with Victron GX & inverter/charger

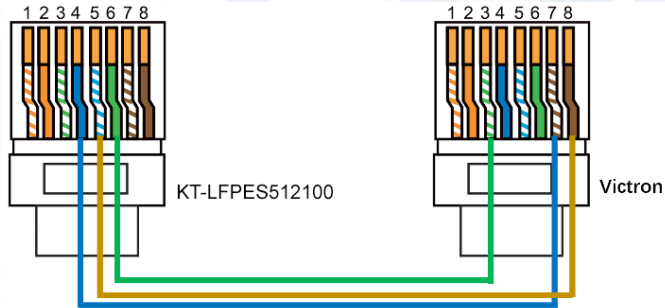

Battery Link IN port	Victron VE.CAN/BMS CAN	Cable suggest
Pin4	Pin7	Version-I(CAN)
Pin5	Pin8	
Pin6	Pin3	

Connect with Deye hybrid inverter

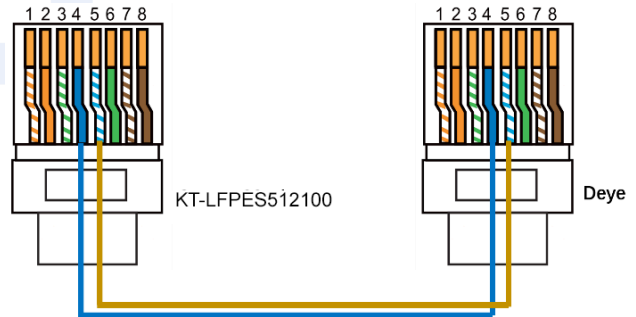

Battery Link IN port	Deye CAN	Cable suggest
Pin4	Pin4	Version-II(CAN)
Pin5	Pin5	